

LU5

Colonne luminose



LED



85dB ad 1m
(Versione FB)

2 Suoni elettrici
(Versione FB)

ø50

IP65

**NPN/PNP
Open collector**

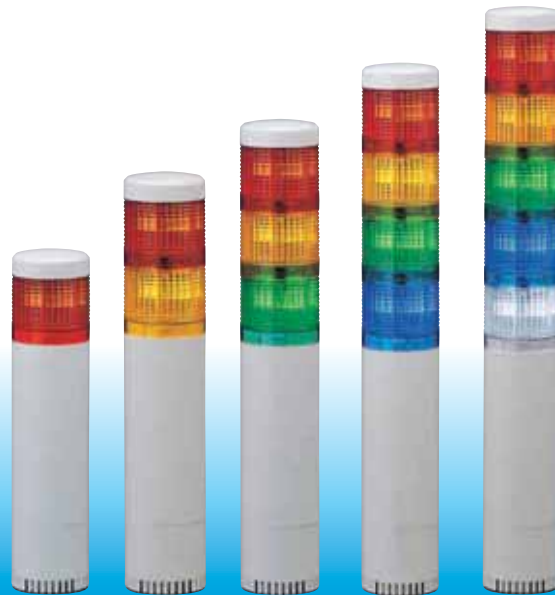

Colonne luminose modulari di facile montaggio e cablaggio per ogni necessità.

- Lenti a prisma esclusive brevettate PATLITE: per intensificare la visibilità da qualsiasi direzione e distanza.
- Allarmi incorporati (Versione FB): 2 allarmi sonori fino a 85dB ad 1m.
- Installazione: montaggio diretto o a paletto*
- Morsetti corrispondenti allo stesso colore dei moduli.
- Moduli LED intercambiabili: ricablaggio non necessario anche dopo l'installazione.
- Lenti: in policarbonato per una maggiore resistenza agli urti ed al calore, per una lunga durata e per una maggiore trasmissione della luce.
- Colori disponibili: rosso, giallo, verde, blu, bianco.

Opzioni su richiesta

- Conformi alle direttive RoHS.
- Silver body
- I moduli dello stesso colore possono essere modificati per lavorare da diversi terminali.

* paletto opzionale da ordinare separatamente

Moduli LED



Colore modulo	Modello	Tensione nominale	Tensione di lavoro	Corrente	Temperatura di lavoro	Peso
Rosso	LU5-E-R	24V DC	Tensione nom. ± 10% (21.6-26.4V)	52mA/1.25W	-30°C~+60°C	44g ±10%
Giallo	LU5-E-Y					
Verde	LU5-E-G					
Blu	LU5-E-B					
Bianco	LU5-E-C					

Come ordinare

Modulo LED	Modulo base
LU5-E-R	LU5-02FB
Unità LED	
Colori: R: Rosso Y: Giallo G: Verde B: Blu C: Bianco	Tipi: Blank: luce continua FB: luce continua o intermittente luce con allarme sonoro
Tensione nominale 02: 24V DC	

Moduli base



Modello	Opzioni	Tensione nominale	Tensione di lavoro	Temperatura di lavoro permessa	Peso	Open Collector
LU5-02	Solo continua	24V DC	Tensione nom. ± 10% (21.6-26.4V)	-30°C~+60°C	182g ±10%	PNP/NPN
LU5-02FB	2 suoni intermittente				200g ±10%	

Tipico FB: circa 60±12 intermittenze al minuto

Dimensioni

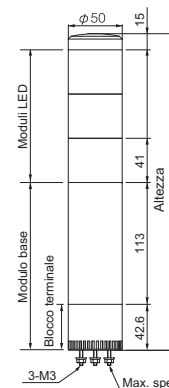

Modello LU5

Altezza (mm)
1 luci: 211
2 luci: 252
3 luci: 293
4 luci: 334
5 luci: 375

Dimensioni di montaggio



Diagramma di collegamento

LU5-02FB
24V DC

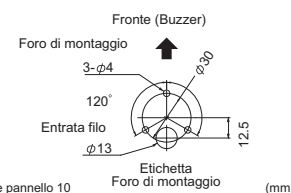
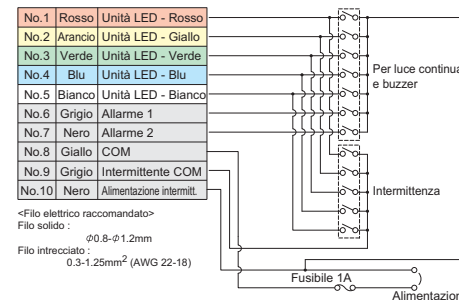

Parti opzionali

Staffa superiore

SZ-60-U



Per montaggio con paletto



Staffa di montaggio

SZ-010
(Per paletto ø21.7mm)

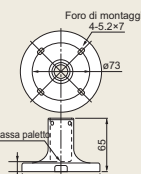

SZ-016A
(Per paletto ø21.7mm)

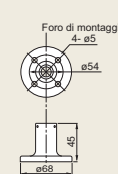

Paletti in acciaio

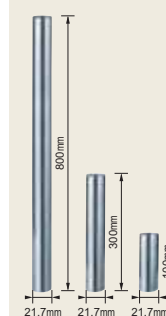

800mm : **POLE-800S21**
300mm : **POLE-300S21**
100mm : **POLE-100S21**

Paletti in alluminio

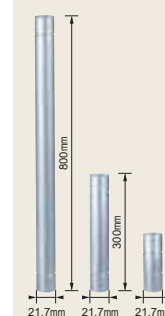

800mm : **POLE-800A21**
300mm : **POLE-300A21**
100mm : **POLE-100A21**

Staffa per montaggio a parete

SZ-020
(Per palo ø21.7mm)



Dimensioni di montaggio

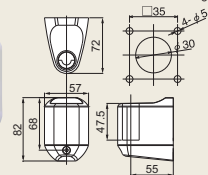

Modello	Modulo
POLE- S21	Acciaio
POLE- A21	Alluminio
SZ-010	ADC12
SZ-016A	ADC12
SZ-70-B	Resina ABS
SZ-020	Resina ABS

* ADC12... Alluminio pressofuso