

Digital Fiber Optic Amplifier (BF5) Communication Converter

■ Features

- Sets all Functional performance and parameters from external devices (PL, PLC)
- Supports various communications : RS485 communication, Serial Communication, SW input
- Connected up to 32 amplifier units (BF5 series)
- Slim design with depth 10mm (W10×H30×L70mm)

⚠ Please read "Caution for your safety" in operation manual before using.



■ User Manual

- Visit our web site (www.autonics.com) to download user manual and communication manual.
- User manual describes for specifications and function, and communication manual describes for RS485 communication (Modbus RTU protocol) and parameter address map data.

■ Comprehensive Device Management Program (DAQMaster)

- DAQMaster is comprehensive device management program to set parameter and manage monitoring data.
- Visit our website (www.autonics.com) to download user manual and comprehensive device management program.

< Computer specification for using software >

Item	Minimum requirements
System	IBM PC compatible computer with Intel Pentium III or above
Operations	Microsoft Windows 98/NT/XP/Vista/7/8/10
Memory	256MB+
Hard disk	1GB+ of available hard disk space
VGA	Resolution: 1024×768 or higher
Others	RS-232 serial port (9-pin), USB port

< DAQMaster screen >

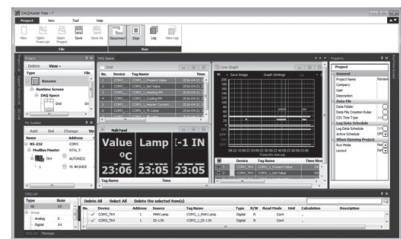

■ Specifications

Model	NPN Solid-state input		PNP Solid-state input	
	BFC-N		BFC-P	
Power supply ^{※1}	12-24VDC ±10%			
Current consumption	Max. 40mA			
SW input (SW1, SW2)	LOW: 0-1V, HIGH: 5-24V SW1/SW2 - HH: Standby, HL: BANK0, LH: BANK1, LL: BANK2		SW1/SW2 - LL: Standby, LH: BANK0, HL: BANK1, HH: BANK2	
Communication function	RS485 communication, serial communication, SW input			
Communication speed	1200, 2400, 4800, 9600, 19200, 38400bps			
Indication	<ul style="list-style-type: none"> • Parameter: Red 4-digit 7-segment • Set value: Green 4-digit 7-segment • Indicator: TX indicator (red), RX indicator (green) 			
Function	<ul style="list-style-type: none"> • Real-time monitoring (incident light level, on/off state) • Executes every BF5 feature and sets parameter by external device (PC, PLC) 			
Environment	Ambient temperature	-10 to 50°C, storage: -20 to 60°C		
	Ambient humidity	35 to 85%RH, storage: 35 to 85%RH		
Vibration	1.5 mm amplitude at frequency of 10 to 55Hz (for 1 min) in each X, Y, Z direction for 2 hours			
Shock	500m/s ² (approx. 50G) in each X, Y, Z direction for 3 times			
Protection structure	IP40 (IEC standard)			
Material	Case: Polybutylene terephthalate, Cover: Polycarbonate			
Accessory	Connector type wire (Ø4mm, 3-wire, 2m) (AWG 22, core diameter: 0.08mm, number of cores: 60, insulator out diameter: Ø1.25mm), Side connector			
Approval	CE			
Unit weight	Approx. 15g			

※1: Power is supplied from the voltage of the amplifier unit connected by a side connector.

※Environment resistance is rated at no freezing or condensation.

(A) Photoelectric Sensors

(B) Fiber Optic Sensors

(C) Door/Area Sensors

(D) Proximity Sensors

(E) Pressure Sensors

(F) Rotary Encoders

(G) Connectors/ Connector Cables/ Sensor Distribution Boxes/ Sockets

(H) Temperature Controllers

(I) SSRs / Power Controllers

(J) Counters

(K) Timers

(L) Panel Meters

(M) Tacho / Speed / Pulse Meters

(N) Display Units

(O) Sensor Controllers

(P) Switching Mode Power Supplies

(Q) Stepper Motors & Drivers & Controllers

(R) Graphic/ Logic Panels

(S) Field Network Devices

(T) Software

BFC Series

Control Output Diagram And Terminal Connections

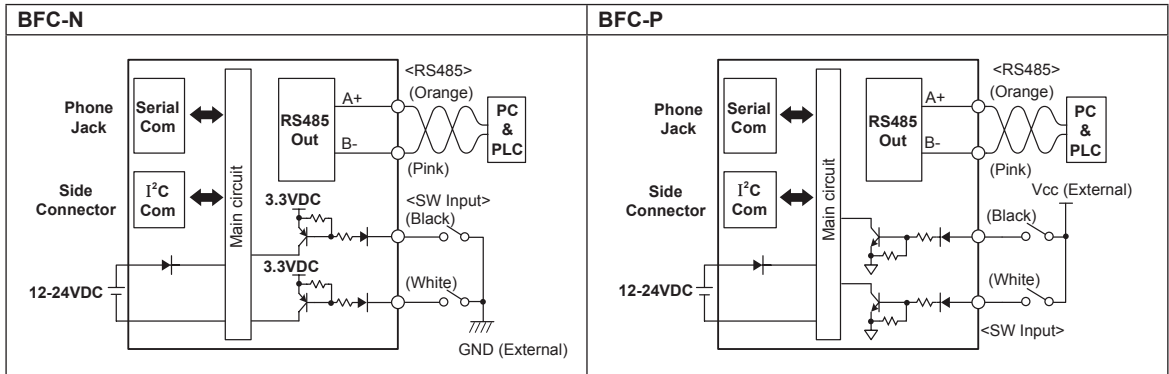

Dimensions

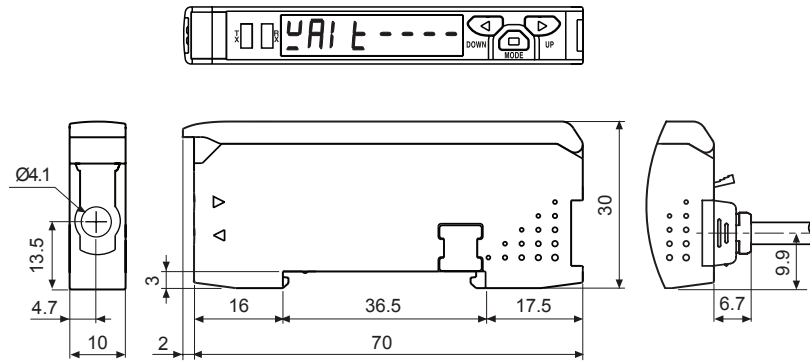

(unit: mm)

Accessories

- Connector type wire (length: 2m)

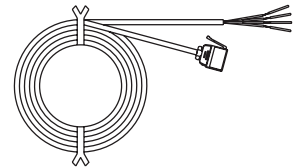

- Side connector



Installations

DIN rail installations

- Attachment: Hang up the backside holder on the DIN rail and press the unit toward the DIN rail.
- Detachment: Slide the back part of the unit as the ① figure and lift up the unit as the ② figure.

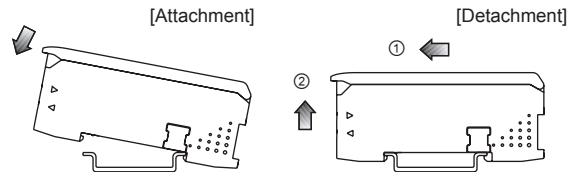

Communication converter unit (BFC series) and Amplifier unit (BF5 series) Connection

- Remove the side cover at the side of communication converter unit where amplifier unit will be connected.
- Attach the side connector to the socket on the side of the communication converter.
- ※Be sure that if you connect a side connector with excessive force, it may cause extruded pins.
- After attaching the communication converter unit and the amplifier unit to the DIN rail, push gently to make both units fastened into each other.
- ※Improper connection may cause malfunction.
- ※Do not supply the power while connecting or disconnecting.

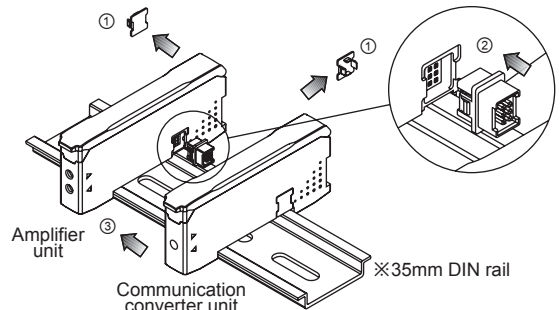

Connector cable attachment and detachment

- Attachment: Insert the connector cable into the installed communication converter unit on DIN rail until it clicks.
- Detachment: Pull out the connector cable by pressing the connector cable lever downside.

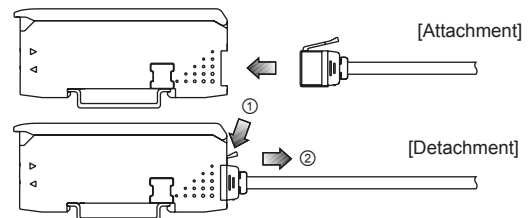

Communication Converter

◎ USB to Serial converter (SCM-US) attachment and detachment

- Connect the USB to Serial converter, SCM-US (sold separately), to PC loader port.

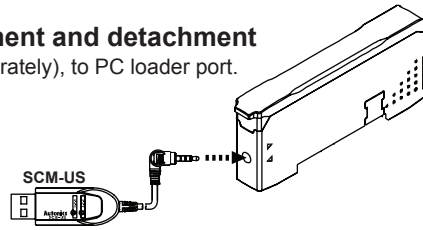

■ Communication Converter (sold separately)

- **SCM-38I**
(RS232C to RS485 converter)
- CE



- **SCM-US48I**
(USB to RS485 converter)
- CE



- **SCM-US**
(USB to serial converter)
- CE



■ Unit Description

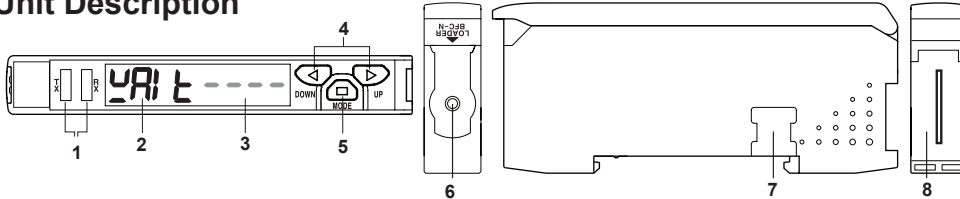

1. TX (Send)-Red LED, RX (Receive)-Green LED: Turns on when communicating and inputting SW.
2. Parameter indication (4-digit red 7seg.): Indicates parameter and processes of communication instruction/execution.
3. Set value indication (4-digit green 7seg.): Indicates set value and process of communication instruction/execution.
4. UP, DOWN key: To modify set value
5. MODE key: To shift or select parameter when entering parameter setting mode.
6. PC loader port: In case of PC communication, use USB to Serial converter (SCM-US, sold separately).
7. Side cover: To connect an amplifier unit, use a side connector (accessory). Remove a side cover to connect an amplifier unit.
8. Connector cable port: Terminal for attaching a connector cable (accessory) is used for RS485 communication or SW input.

■ Communication Mode

This communication converter unit supports 2 communication modes and SW input mode.

You can use only 1 mode of 3 modes.

1) Serial communication

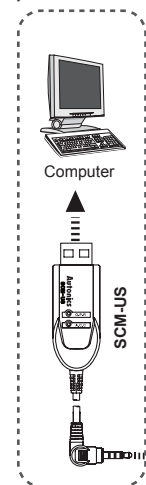

Caution
Do not connect a powered BF5 connector cable to a communication converter unit (BFC). (It may cause damage the product.)

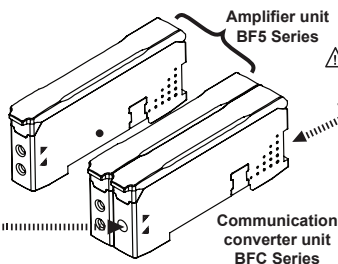

2) RS485 communication

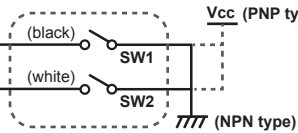
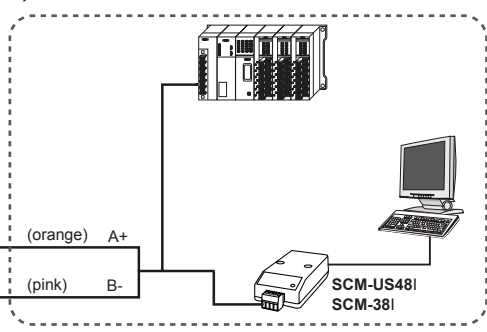

1) Serial communication

- ① Connect the USB to Serial converter (SCM-US, sold separately) to the PC loader port for communicating with PC.
- ② It is very easy to manage parameters and monitor data of connected amplifier units (BF5 series) by using the integrated management program DAQMaster (free).

(A) Photoelectric Sensors

(B) Fiber Optic Sensors

(C) Door/Area Sensors

(D) Proximity Sensors

(E) Pressure Sensors

(F) Rotary Encoders

(G) Connectors/ Connector Cables/ Sensor Distribution Boxes/ Sockets

(H) Temperature Controllers

(I) SSRs / Power Controllers

(J) Counters

(K) Timers

(L) Panel Meters

(M) Tacho / Speed / Pulse Meters

(N) Display Units

(O) Sensor Controllers

(P) Switching Mode Power Supplies

(Q) Stepper Motors & Drivers & Controllers

(R) Graphic/ Logic Panels

(S) Field Network Devices

(T) Software

BFC Series

2) RS485 communication

- PLC connection: ① Connect directly to a PLC by using RS485 communication cable of the communication converter unit.
② Amplifier units (BF5 series) can be controlled through PLC.
 - PC connection: ① Connect PC by using Communication converter (SCM-38I, SCM-US48I, sold separately).
② It is very easy to manage parameters and monitor data of connected amplifier units (BF5 series) by using the comprehensive device management program DAQMaster (free).
- ※Following is a screen of DAQMaster properties window of a computer connected communication converter unit.

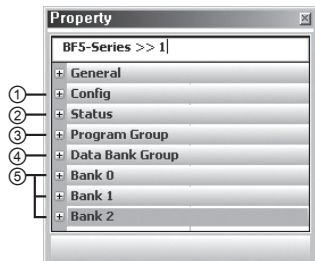

- ① **Config**
Indicates the number of amplifier units connected to the communication converter unit (BFC).
- ② **Status**
Indicates the information of the selected amplifier unit (dual, single) by channel, connected to communication converter unit (BFC).
- ③ **Program group**
Set values of the amplifier unit can be changed. When set values of the amplifier unit are changed, TX (red) and RX (green) LEDs on communication converter unit will flash indicating application of set values to the amplifier unit.
- ④ **Data Bank Group**
Data bank and group teaching features of amplifier unit can be set. Amplifier unit can be initialized as well.

※Indications appear on communication converter and amplifier units depending on applied instruction as below.

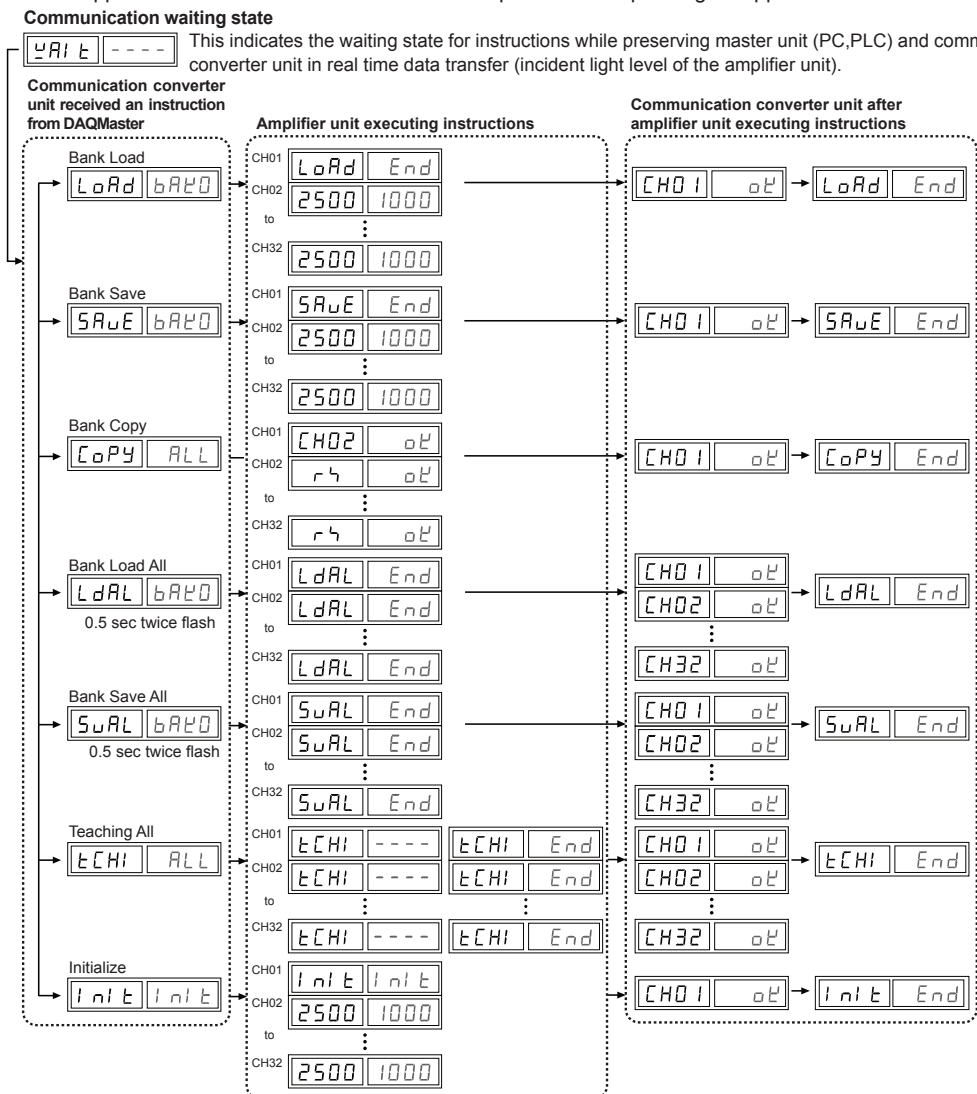

⑤ **Data Bank**: Set value of data bank (Bank 0, Bank 1, Bank 2) can be saved.

Communication Converter

3)SW input

SW input is a feature which allows amplifier unit connected with the communication converter unit to load all banks. Applying signals to SW1 (Black) and SW2 (White) of the connector cables connected to the communication converter unit allows change of banks as shown in chart 1. (SW input signal duration should be longer than 3 seconds.)

[Chart 1] Bank selection table based on SW input

	Bank	NPN		PNP	
		SW1	SW2	SW1	SW2
1	Standby signal (Using set Bank)	H	H	L	L
2	Bank 0	H	L	L	H
3	Bank 1	L	H	H	L
4	Bank 2	L	L	H	H

※Indications appear on communication converter and amplifier units depending on applied instruction as below.

SW input standby state

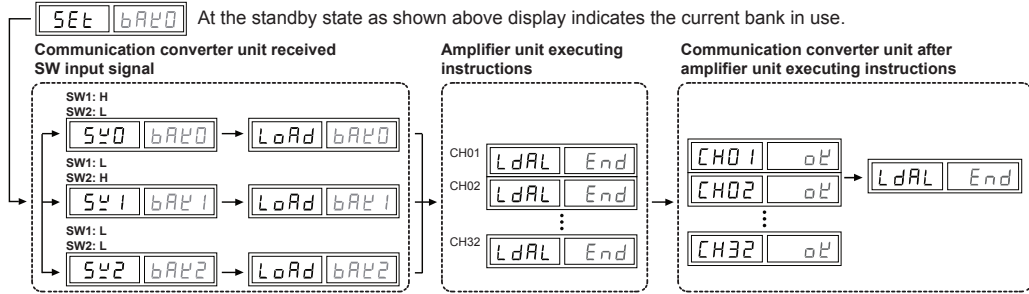

< Communication specification >

Standard	EIA RS485	Standard	EIA RS485
Maximum connections	31 (address setting: 01 to 99)	Response waiting time	20 to 99ms
Communication method	2-wire half duplex	Start bit	1-bit (fixed)
Synchronization method	Asynchronous	Stop bit	1-bit, 2-bit
Effective communication distance	Max. 800m	Parity bit	None, Even, Odd
Communication speed	1200, 2400, 4800, 9600, 19200, 38400bps	Data bit	8-bit (fixed)
		Protocol	Modbus RTU

※It is not allowed to set overlapping communication address at the same communication line.

※Please use a proper twist pair for RS485 communication.

Parameter Setting

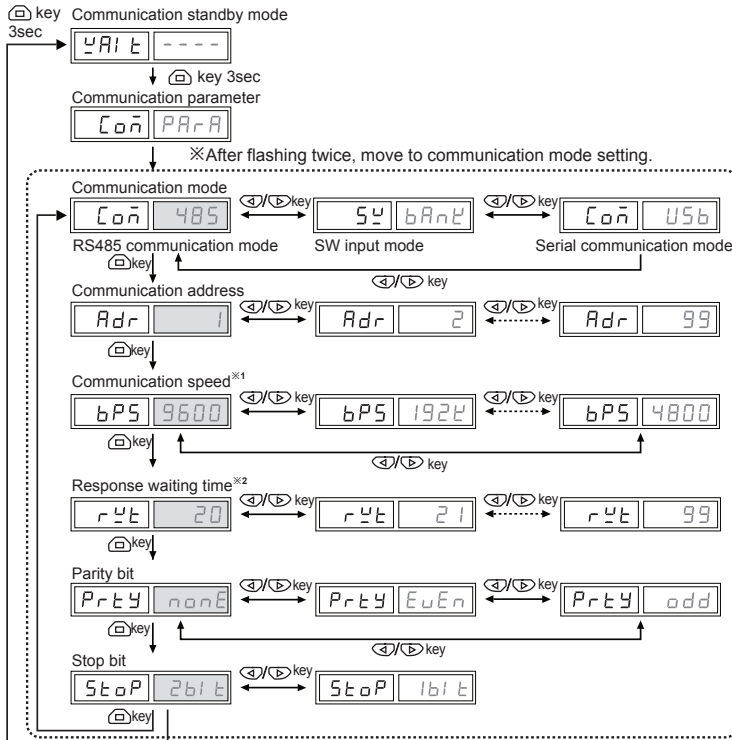

※1:

Communication speed display	
Speed	Display
1200	1200
2400	2400
4800	4800
9600	9600
19200	1924
38400	3844

※2: Communication response waiting time ranges is 20 to 99ms (Depending on the number of amplifier units connected, response time may increase up to 350ms.)

※: Factory default

(A)	Photoelectric Sensors
(B)	Fiber Optic Sensors
(C)	Door/Area Sensors
(D)	Proximity Sensors
(E)	Pressure Sensors
(F)	Rotary Encoders
(G)	Connectors/ Connector Cables/ Sensor Distribution Boxes/ Sockets
(H)	Temperature Controllers
(I)	SSRs / Power Controllers
(J)	Counters
(K)	Timers
(L)	Panel Meters
(M)	Tacho / Speed / Pulse Meters
(N)	Display Units
(O)	Sensor Controllers
(P)	Switching Mode Power Supplies
(Q)	Stepper Motors & Drivers & Controllers
(R)	Graphic/ Logic Panels
(S)	Field Network Devices
(T)	Software

BFC Series

■ Error Code

Error code	Cause	Troubleshooting
<i>ErA</i>	Reading/Writing errors occur while processing data in EEPROM of amplifier unit.	Check the circuitry around EEPROM inside the product.
<i>ErB</i>	<ul style="list-style-type: none">• Slave fails to execute Master's group instructions such as Copy/Load/Save/Teaching sent through communication line due to unstable communication line.• Other communication problems.	<ul style="list-style-type: none">• Check the connection status between communication unit and amplifier units.• Check the circuitry around the side connector and hardware condition.

Solution methods for communication problems

1) Communication errors during Serial or RS485 connections

- Check if the communication mode selected in communication converter unit suits in installation environment.
- Check and equalize the address of communication converter unit and address set in DAQMaster.
- Check and equalize the communication port of communication converter unit and the communication port number set in DAQMaster.

2) Communication errors during SW signal input

- Check if the communication mode set in communication converter unit is SW input mode (SW Bank).
- Check if the connections are made thoroughly depending on NPN or PNP input type.