

- For limit level measurement of liquids (even if polluted), mash and paste materials in open or closed vessels, sumps, open channels, drains, etc.
- Variants of level sensor with adjustment by two buttons, or by magnetic pen
- Xi version for usage in explosive areas
- State indication by two LEDs
- Output is PNP transistor with an open collector (max. switch current 300 mA) or two-state current switch 4 mA / 20 mA
- Wide choice of electric connection via connectors, cable glands or protective conductor
- Reception of reflected ultrasonic signal from level can be improved using horn adapter



The ULS[®] ultrasonic level sensor are compact measurement devices containing an ultrasonic transmitter and an electronic module. Using an transmitter, level sensor transmit the series of ultrasonic pulses that spread towards the level surface. The transmitter receives reflected acoustic waves that are subsequently processed in the electronic module. Based on the period during which the individual pulses spread towards the level and back, this period is averaged by the electronics that performs temperature compensation and subsequently a conversion to an output. The output of the ULS sensor consists of a PNP transistor with an open collector or a two-state current switch 4 mA / 20 mA.

Thanks to the contactless measuring principle ultrasonic level meters are suitable for continuous measurement or limit level sensing of liquids, waste water, sludge, suspensions, adhesives, resins in various open and closed vessels, sumps, open channels and drains. Use for organic solvents or substances, which contain organic solvents, should be consulted with the manufacturer. Usability for level measurement of solid materials is limited, there is a shorter measuring range. We recommend using the level meter for such a medium to consult with the manufacturer. Setting is carried out either using two buttons or a magnetic pen or by remote setting in case of Modbus RTU output. The device is equipped with optical indication of its state (RUN) and the setting process (STATE). It is manufactured in designs for normal (N) and explosive atmospheres (Xi).

VARIANTS OF SENSORS

- ULS-53_-01-_ measurement range 0.1 m to 1 m, all-plastic design, source of PVDF (polyvinylidene fluoride), mechanical connection with thread G ¾.
- ULS-53_-02-_ measurement range 0.20 m to 2 m, all-plastic design, source of PVDF, mechanical connection with thread G 1".
- ULS-53_-06-_ measurement range 0.20 m to 6 m, all-plastic design, source of PVDF, mechanical connection with thread G 1 ½".
- ULS-53_-10-_ measurement range 0.4 m to 10 m, all-plastic case, source of PVDF, mechanical connection with thread G 2 ¼".
- ULS-53_-20-_ measurement range 0.5 m to 20 m, all-plastic case, source of PVDF, mechanical connection with flange of aluminium alloy.

DIMENSIONAL DRAWINGS

ULS-53_-01

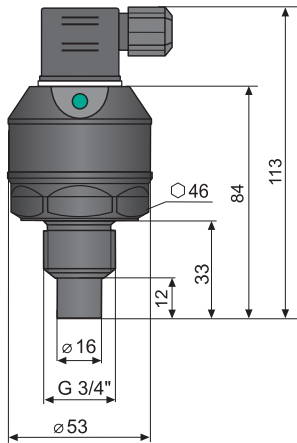

ULS-53_-02

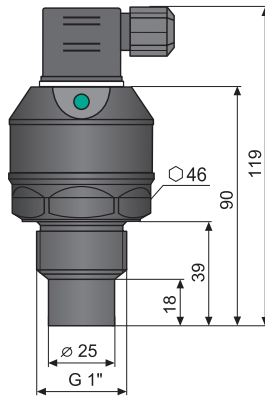

ULS-53_-06

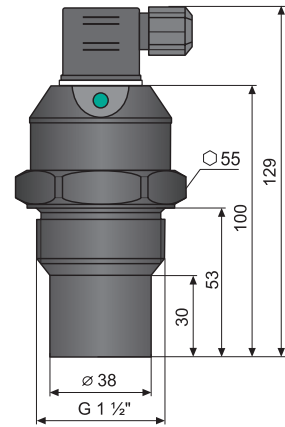

ULS-53_-10

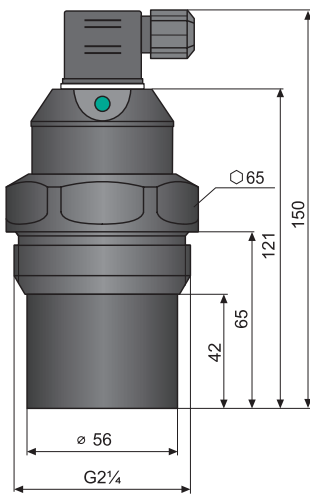

ULS-53_-20

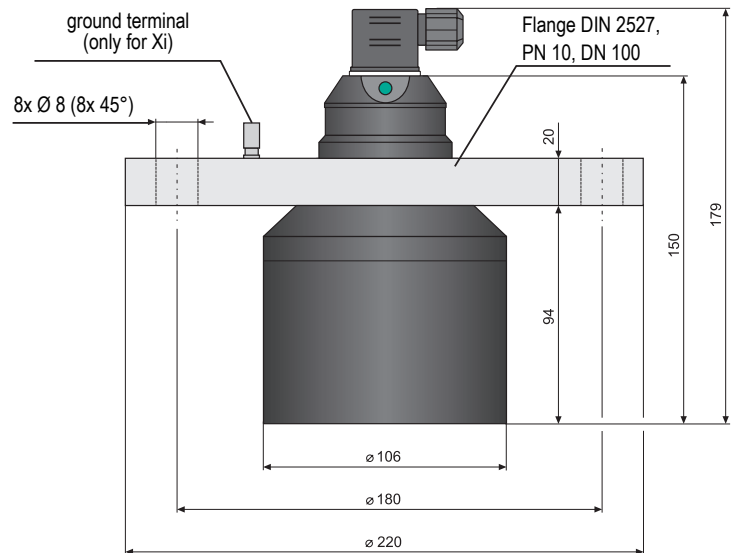

Variant "G" with connector ISO

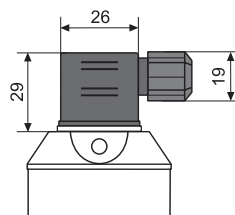

Variant "C" with connector M12

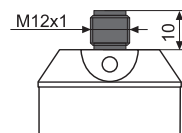

Variant "B" with standard cable gland

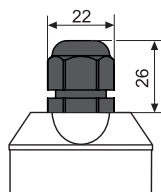

Variant "H" with outlet for protective conductor

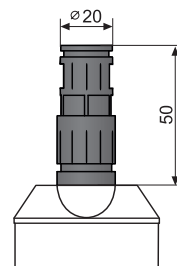

TECHNICAL SPECIFICATIONS

Measuring range ¹⁾	ULS-53_01_	0,1 ... 1 m
	ULS-53_02_	0,2 ... 2 m
	ULS-53_06_	0,2 ... 6 m
	ULS-53_10_	0,4 ... 10 m
	ULS-53_20_	0,5 ... 20 m
Supply voltage	ULS-53N_ _ _ _	18 ... 36 V DC
	ULS-53Xi_ _ _ _S	18 ... 30 V DC
Current supply	ULS-53N_ _ _ _P	max. 12 mA
	ULS-53_ _ _ _S	disconnected 4 mA / connected 20 mA
Current output	ULS-53N_ _ _ _P	PNP transistor with an open collector (max. switch current 300 mA)
Voltage output	ULS-53_ _ _ _S	two-state current switch 4 mA / 20 mA
Resolution		< 1 mm
Accuracy (within the total range)	ULS-53_01_ in area	0,1–0,2 m / 0,2–1,0 m
	ULS-53_02_ ; -06	0,3 % / 0,2 %
	ULS-53_10_ ; -20	0,15 % 0,2 %
Temperature error		max. 0,04% / K
Beam width (-3 dB)	ULS-53_01_ ; 02_ ; 10_	10°
	ULS-53_06_	14°
	ULS-53_20_	12°
Ambient temperature range	ULS-53_01_ ; 02_ ; 06_	-30 ... +70°C
	ULS-53_10_ ; 20_	-30 ... +60°C
Measuring period	ULS-53_01_ ; 02_	0,6 s
	ULS-53_06_	1,0 s
	ULS-53_10_	1,8 s
	ULS-53_20_	5,0 s
Averaging		4 measurement ³⁾
Short time temperature stress resistance		+90°C / 1 hod.
Max. operation overpressure (on transmission surface)		0,1 MPa
Max. internal values ²⁾ (for the Xi version only)		U _i =30 V DC; I _i =132 mA; P _i =0,99 W; C _i =370 nF; L _i =0,9 mH
Failure indication	echo failure – basic mode	3,75 mA / 0 V
	echo failure – inverse mode	22 mA / 10,5 V
	level in dead zone ⁴⁾ – basic mode	22 mA / 10,5 V
	level in dead zone ⁴⁾ – inverse mode	3,75 mA / 0 V
Protection class	ULS-53_ _ _ _ _ T	IP67
	ULS-53_ _ _ _ _ G-M	
	ULS-53_ _ _ _ _ C-M	IP67 ⁵⁾
	ULS-53_ _ _ _ _ B-M	
	ULS-53_ _ _ _ _ H-M	IP68
Recommended cable		PVC 2 x 0,75 mm ² (3 x 0,5 mm ²)
Maximal current output load resistance	at U = 24 V DC	R _{max} = 270 Ω
	at U = 22 V DC	R _{max} = 180 Ω
	at U = 20 V DC	R _{max} = 90 Ω
Minimal voltage output load resistance		R _{min} > 1 kΩ
Delay between supply power rise time and first measurement	ULS-53_01_ ; 02_ ; 06_	5 s
	ULS-53_10_ ; 20_	9 s
Process connection	ULS-53_01_	thread G 3/4"
	ULS-53_02_	thread G 1"
	ULS-53_06_	thread G 1 1/2"
	ULS-53_10_	thread G 2 1/4"
	ULS-53_20_	flange DIN 2527, PN 10, DN 100
Weight	ULS-53_01_	0,20 kg
	ULS-53_02_	0,20 kg
	ULS-53_06_	0,25 kg
	ULS-53_10_	0,65 kg
	ULS-53_20_	2,80 kg

¹⁾ In case the level of bulk-solid materials is measured, the measurement range is reduced.

²⁾ Allowed pressure range in the zone 0: 80 ... 110 kPa.

³⁾ From the last six measurements are taken out extreme values MAX and MIN, then the remaining four measurement was performed arithmetic average.

⁴⁾ Dead zone = blind zone = blocking zone.

⁵⁾ Protection class IP68 can be achieved when a special connector is used.

WORKING AREAS AND AREA CLASSIFICATION (under EN 60079-10 and EN 60079-14)

UL_-53N-_-_-	Basic performance for non-explosive atmospheres.
ULS-53Xi-01-I ULS-53Xi-02-I ULS-53Xi-06-I	Intrinsically safe explosion-proof performance for use in hazardous areas (explosive gas atmospheres) Ⓜ II 1/2G Ex ia IIB T5 Ga/Gb with intrinsically safe supply units ¹⁾ , whole level sensor zone 1, front head part 0.
ULS-53Xi-10-_-S	Intrinsically safe explosion-proof performance for use in hazardous areas (explosive gas atmospheres) Ⓜ II 1/2G Ex ia IIA T5 Ga/Gb with intrinsically safe supply units ¹⁾ , whole level sensor zone 1, front head part 0.
ULS-53Xi-20-_-S	Intrinsically safe explosion-proof performance for use in hazardous areas (explosive gas atmospheres) Ⓜ II 2G Ex ia IIA T5 Gb with intrinsically safe supply units ¹⁾ , whole level sensor zone 1.

¹⁾ Intrinsically safe isolating repeater (e.g. Dinel IRU-420).

MATERIALS

sensor part	type variant	standard material
Housing	all	plastic PP
Electro-acoustic transducer	all	plastic PVDF
Flange	UL_-53_-20	lacquered aluminum alloy
Cable gland	all	plastic PA

RANGE OF APPLICATION

Thanks to the proximity principle employed, the devices are suitable for continuous measurement of the level of liquids, waste water, sludge, suspensions, adhesives, resins in various open and closed vessels, sumps, open channels and drains.

Applicability for measuring the surface level of loose materials is limited, the range of measurement is shorter there. We recommend that the suitability of the level sensor for measuring bulk-solid materials is consulted with the manufacturer.

ELECTRICAL CONNECTION

Connection through ISO connector

The ULS level sensor with a G type cable gland are connected to processing (display) units by means of a cable with an outer diameter of 6 to 8 mm (recommended wire cross-section 0.5 to 0.75 mm²), via a detachable ISO connector with inner screw terminals, which is part of the delivery. The connection diagram and the inner view of the connector are shown in Figures on the right. Non-detachable connector IP67 with PVC cable 5 m long can be supplied as an extra option.

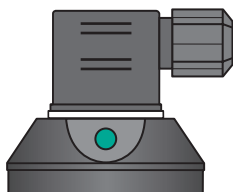

View of the connector ISO

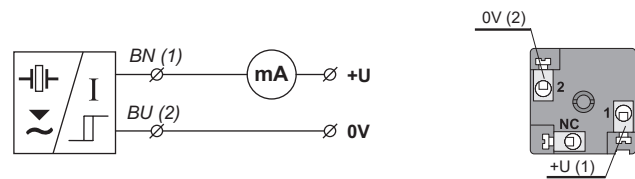

Connection diagram of the ULS sensor with S type output (two-state current switch 4 mA / 20 mA)

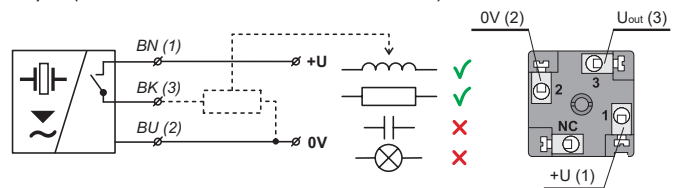

Connection diagram of the ULS sensor with P type output (PNP) with an open collect

Connection through M12 connector

The ULS level sensor with a C type cable gland are connected to processing (display) units by means of a cable with an outer diameter of 4 to 6 mm (recommended wire cross-section 0.5 to 0.75 mm²), via a connector socket with a moulded cable (2 or 5 m long) or via a detachable connector socket without a cable (see accessories), the connector is not basic part of the sensor. In this case connect the cable to the inner socket pins under figures on the right.

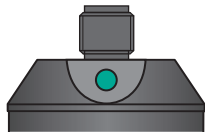

View of the connector M12

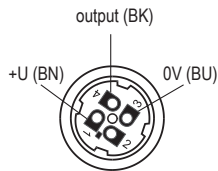

Inside view of the connector socket

Connection via standard gland or gland for protective hoses

The ULS level sensor with a B or H type cable gland are connected to processing (display) units by means of a fixed PVC cable 5 m long. standard cable gland (B) or plastic bushings with a thread for protective hoses (H) can be used as a cable gland. Connection diagrams are shown in Figures on the right.

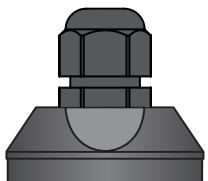

View of the standard cable gland

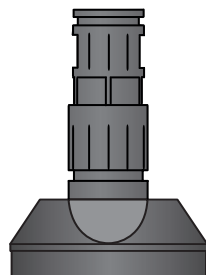

View of the cable gland for protective hose

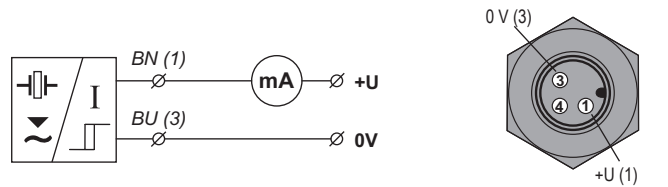

Connection diagram of the ULS sensor with S type output (two-state current switch 4 mA / 20 mA)

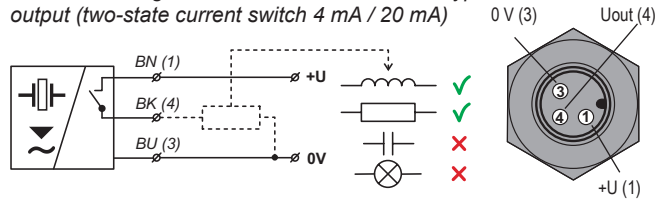

Connection diagram of the ULS sensor with P type output (PNP) with an open collector

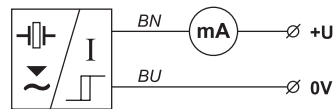

Connection diagram of the ULS sensor with S type output (two-state current switch 4 mA / 20 mA)

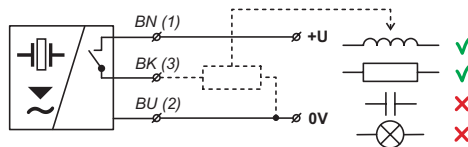

Connection diagram of the ULS sensor with P type output (PNP) with an open collector

Legend:

BK – black
BN – brown
BU – blue



Wiring operations shall only be carried out without voltage!

Taking into account the potential occurrence of electrostatic discharge on non-conducting parts of the level sensor, it is necessary to ground the flange of level sensors ULS-53Xi-20-F, located in an explosive atmosphere, using a ground terminal!



It is also necessary to design and take measures to reduce the effects of static electricity to a safe level in the wiring.

Installation in explosive atmospheres needs to be carried out in compliance with EN 60079-14 (Electrical installations for explosive gaseous atmospheres – Part 14: Electrical installations in dangerous areas other than mining) and possibly also in compliance with other standards relating to the area concerned.



The supply source should be preferably designed as a stabilized source of safe voltage 18 V to 36 V DC (max. 30 VDC for version Xi), which is part of the downstream processing or display system.

In case of strong ambient electromagnetic disturbance, parallel run of the input cable with the power line or its length exceeding 30 m, we recommend using a shielded cable.

SETTINGS

Device type with setting using buttons

The measuring range is setup by means of two buttons "DOWN" and "UP". The "DOWN" button is used to enter to the setting mode (setting the 4 mA or 0V limit) and to decrease the output current or voltage. The "UP" button as an opposite function (setting the 20mA or 10V limit and increasing the output current or voltage). Values are confirmed by simultaneous pressing of both buttons for about 1 sec. The setting process is indicated by yellow "STATE" LED indicator.

For detailed information please read at the instructions manual.

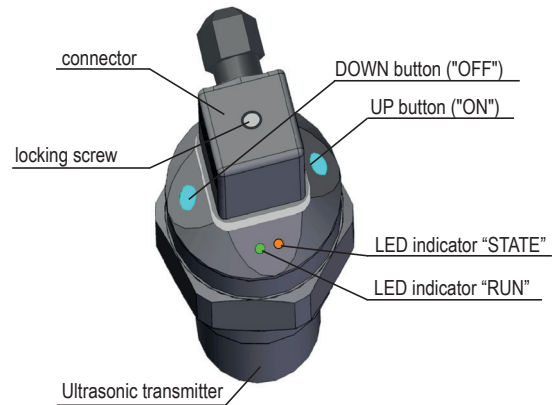

Key parts of the measuring device
(version "T" with buttons)

Device type with setting using a magnetic pen

The measuring range is setup by touching of the magnetic pen to sensitive spots "EMPTY" and "FULL". The "EMPTY" spot is used to enter to the setting mode (setting the 4 mA or 0V limit) and to decrease the output current or voltage. The "FULL" spot as an opposite function (setting the 20mA or 10V limit and increasing the output current or voltage). Values are confirmed by touching of the magnetic pen to the sensitive spot for about 3 sec. The setting process is indicated by yellow "STATE" LED indicator.

For detailed information please read at the instructions manual.

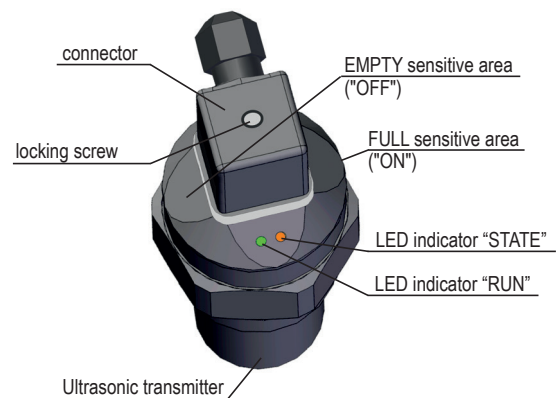

Key parts of the measuring device
(version "M" with magnetic pen setting)

FUNCTION AND STATUS INDICATION

LED indicator	Colour	Function
"RUN"	green	<p>short flashing (repeated depending on the measurement interval approx. 1 ... 2 s) - correct function, receipt of signal (echo) reflected from the measured surface</p> <p>fast flashing – the measured surface is in the dead zone of the level sensor or the ultrasound transducer is dirty</p> <p>off – the level sensor is not capable of receiving the echo. Incorrect installation or malfunction</p>
"STATE"	orange	<p>Output status indication</p> <ul style="list-style-type: none"> off – sensor output is disconnected (OFF) on – sensor output is connected (ON) <p>Indication setting</p> <ul style="list-style-type: none"> slow flashing – setting indication for the disconnected status fast flashing – setting indication for the connected status 3 short flashes – setting confirmation

ORDER CODE

PRODUCT

ULS - 53

MECHANICAL PERFORMANCE

- N non-explosive atmosphere
- Xi  explosive atmosphere

MAXIMUM RANGE

- 01 0,10 ... 1 m, process connection F cannot be selected
- 02 0,20 ... 2 m, process connection F cannot be selected
- 06 0,20 ... 6 m, process connection F cannot be selected
- 10 0,40 ... 10 m, process connection F cannot be selected
- 20 0,50 ... 20 m, process connection G cannot be selected

PROCESS CONNECTION

- G pipe thread
- F flange

TYPE OF OUTPUT

- P PNP switching transistor with an open collector
- S two-state current switch 4 mA / 20 mA

ELECTRICAL CONNECTION

- G connector ISO
- C connector M12
- B standard cable gland
- H cable gland for protective hose

SET-UP ELEMENTS

- T setting using buttons
- M setting using a magnetic pen (MP8)

CABLE

- K cable length in m) (only for variants with connection type "B" and "H")

ULS-53 N - 20 - F - P - H - M K 5

EXAMPLE OF CODING

CORRECT SPECIFICATION EXAMPLES

ULS-53N-02-G-P-G-T

(N) Performance for non-explosive areas; (02) maximum range 0,2 ... 2 m; (G) process connection pipe thread; (P) PNP switching transistor with an open collector; (G) connection method ISO connector; (T) set-up elements buttons.

ULS-53N-20-F-P-H-M cable 5m

(N) Performance for non-explosive areas; (20) maximum range 0,5 ... 20 m; (F) process connection flange; (P) PNP switching transistor with an open collector; (H) connection method cable gland for protective hose; (M) set-up elements magnetic pen (MP8).

ULS-53Xi-06-G-S-B-T cable 5m

(Xi) Explosive environments performance; (06) maximum range 0,2 ... 6 m; (G) process connection pipe thread; (S) two-state current switch 4 mA / 20 mA; (B) connection method standard cable gland; (T) set-up elements buttons.

ACCESSORIES

standard (included in the level sensor price)

- 1x seal (for ULS-53_ 01; 02; 06; 10)
- 1x connector with IP 67 coverage (for versions with an ISO connector)
- 1x magnetic pen MP-8 (for device type adjusted with a magnetic pen)

optional – for a surcharge (see catalogue sheet of accessories)

- plastic fastening nuts PUM-G0,75; PUM-G1; PUM-G1,5; PUM-G2,25
- horn adapter ST-G0,75 (thread G3/4"), ST-G1 (thread G1"), ST-G1,5 and ST-G2,25
- stainless steel or steel nipples NN-G1; ON-G1, NN-G1,5; ON-G1,5
- socket ELWIKA 4012 K PG7 or ELKA 4012 K PG7
- connector with IP67 protection (type GAN-DADE 7A) with 5 m cable (for current output and ISO type connector)
- connector with IP67 protection (type GAN-DAEE 7A) with 5 m cable (for voltage output and ISO type connector)
- protective hose (for version with "H" type terminal)

SAFETY, PROTECTIONS, COMPATIBILITY AND EXPLOSION PROOF

Level sensor ULS-53 is equipped with protection against electric shock on the electrode, reverse polarity, output current overload, short circuit and against current overload on output.

Protection against dangerous contact is provided by low safety voltage according to 33 2000-4-41. Electromagnetic compatibility is provided by conformity with standards EN 55011/B, EN 61326-1 and EN 61000-4-2 to 6.

Explosion proof ULS-53Xi is provided by conformity with standards EN 60079-0:2007, EN 60079-11:2007, EN 60079-26:2007.

Explosion proof ULS-53Xi is verified FTZÚ – AO 210 Ostrava – Radvanice: FTZÚ 09 ATEX 0119X.

A declaration of conformity was issued for this device in the wording of Act No. 90/2016 Coll., as amended. Supplied electrical equipment matches the requirements of valid European directives for safety and electromagnetic compatibility.

Special conditions for safe use of variants ULS-53Xi

The device is designed for connection to the isolating repeater IRU-420. When the other approved supply unit is used, whose output parameters satisfy above mentioned output parameters, it is necessary to have a galvanic separation or, if supply unit without galvanic separation is used (Zener barriers), it is necessary provide potential equalization between sensor and point of barrier earthing.

For application in zone 0 the present explosive atmospheres - mixture of air with flammable gases, vapour or mists must comply:

- 20°C < Ta < + 60°C; 0.8 bar < p < 1.1 bar.

The device must be installed in such a way, to prevent mechanical damage of sensor face.

Maximum input parameters:

Ui = 30 V; Ii = 132 mA; Pi = 0.99 W; Ci = 370 nF; Li = 0.9 mH

PACKINGS, SHIPPING AND STORAGE

The ULS-53 device is supplied packaged in a cardboard box that protects it against mechanical damage.

When handling and during transport, it is necessary to prevent impacts and falls.

The ULS-53 electrical device must be stored in dry enclosed areas with humidity up to 85%, free of aggressive vapours at temperatures between -20°C and 60°C, and must be protected against the effects of weather.

version: 10/2020