

SSU-1211  
SSU-2411

DSU-1222  
DSU-2422

## POWER SUPPLY AND SWITCHING UNITS

Sensor power supply and conversion their state to a power contact.



CE

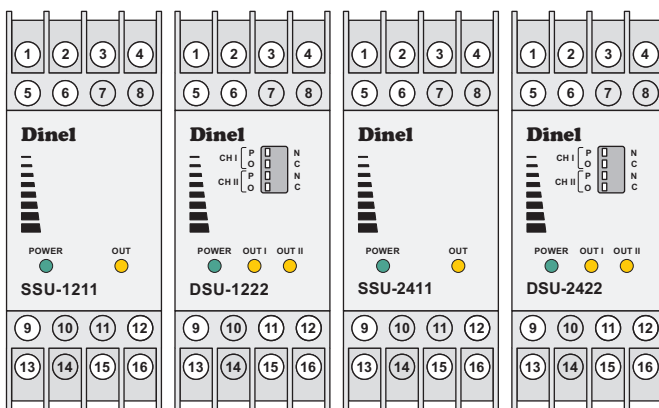

### SSU

- **Single-channel power supply and evaluation units.**
- **Power supply of sensors and transfer of their state to the power contact.**
- **Connection of two-state sensors with all kinds of outputs.**
- **Output supply voltage 12 V or 24 V.**

### DSU

- **Dual-channel power supply and evaluation units.**
- **Power supply of sensors and transfer of their state to the power contact.**
- **Connection of two-state sensors with all kinds of outputs.**
- **Output supply voltage 12 V or 24 V.**

### Technical specifications

	SSU-1211 DSU-1222	SSU-2411 DSU-2422
Supply voltage	230 V / 50 Hz	
Power demand	4 VA	
Output voltage (terminals 5,6 - 1,2)	12 V DC	24 V DC
Allowed supply voltage tolerance	± 5 %	
Maximum total load current	150 mA	
Short-circuit output current	type 500 mA	
Maximum short-circuit duration at output	unlimited	
Short circuit current of inputs	max. 6 mA	
Input terminals	after switching after disconnection tipping level	min. 2 mA max. 1 mA type 1,5 mA
Contact load capacity	max. current max. voltage max. power	3 A 250 V 500 VA
Max. switching frequency of loaded contacts	360 / h	
Contact lifetime	min. 10 <sup>6</sup> cycles	
Electric strength - mains 230V - output 12 V	4 kV	
Ambient working temperature	-20 °C ... + 50 °C	
Cover protection box	SSU-1211 / 2411 DSU-1222 / 2422	IP 40 IP 20
Cover protection terminals	SSU-1211 / 2411 DSU-1222 / 2422	IP 20 IP 20
Housing material	polycarbonate	
Terminal material	CuBe	
Max. / recommended conductor cross-section	4 mm <sup>2</sup> / 0,5 ±1 mm <sup>2</sup>	
Weight	approx. 0,15 kg	
Connection to 230 V mains only trough a switch or circuit breaker		
Internal protection on 230 V side by fuse T 500 mA		
Electrical equipment of protection class II		
Electrical safety requirements due to EN 61010-1		
EMC EN 61000-4-2,-3,-4,-5,-6,-11, EN 55011, EN 61326-1		

## BASIC FEATURES AND VARIANTS

### SSU-1211 / 2411

It is a single channel power supply unit that evaluates the status of the connected sensor (terminal 3) and transfers it to the power contact (terminals 12, 15, 16). The type of connected sensor is selected by connecting terminal 4 to terminal 1 or 5.

### DSU-1222 / 2422

It is a two-channel power supply unit that evaluates the status of the connected sensors (terminal 3 and terminal 4) and transfers it to the power contact (CH I terminals 15, 16 and CH II terminals 11, 12). The selection of the type of connected sensor is done by the P/N switch and the selection of the encoder status repeat or inverse function by the O/C switch.

## DIMENSIONS

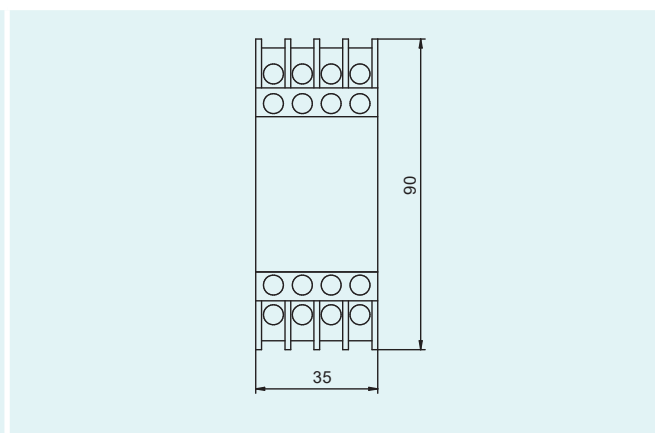
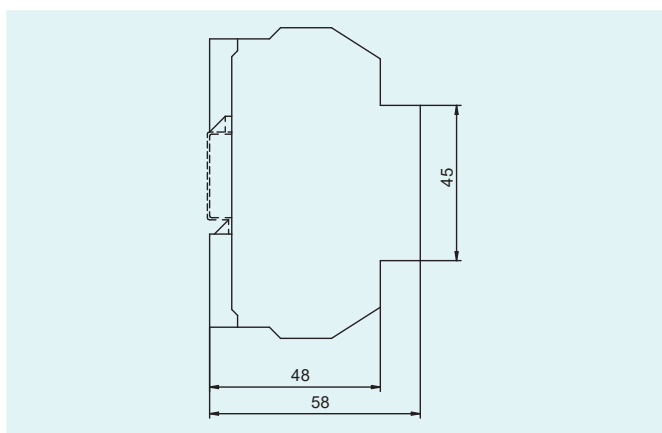

# FRONT PANELS AND TERMINAL NUMBERING

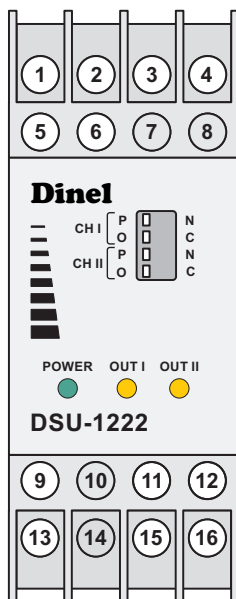
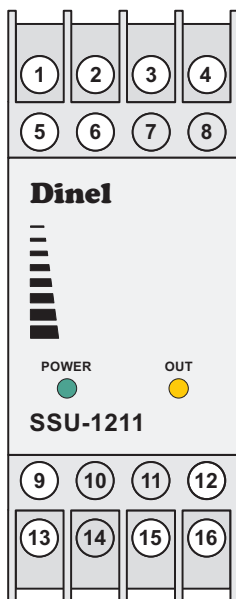

## Signalling LEDs

SSU-1211, SSU-2411, DSU-1222, DSU-2422

Green „**POWER**“

- ON - connection of 230 VAC supply, correct function
- OFF - failure (short-circuit at supply terminals)

Orange „**OUT**“ / „**OUT I a OUT II**“

- ON - output relay is switched on
  - SSU-1211/2411, contact 15, 16 is closed
  - DSU-1222/2422, contact 11, 12 or 15, 16 is closed
- OFF - output relay is switched off (released)
  - SSU-1211/2411, contact 12, 15 is closed
  - DSU-1222/2422, contact 11, 12 or 15, 16 is closed

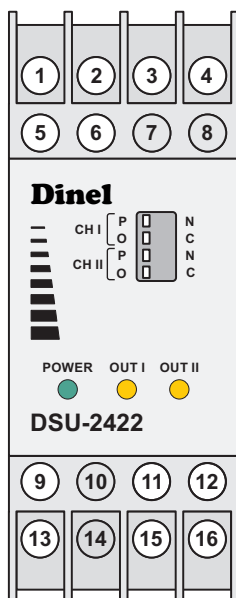
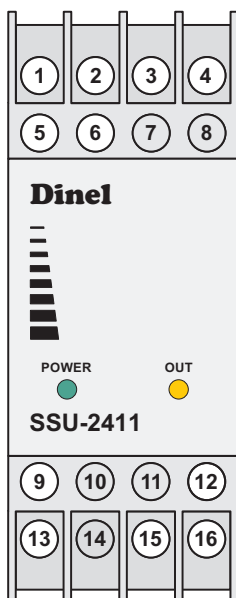

# ELECTRICAL CONNECTION

## BLOCK AND WIRING DIAGRAM SSU-1211 / 2411

### Connection to sensors with NPN, PNP output

+ U of sensor	terminal No. 6
output (Q) of sensor	terminal No. 3
0 V of sensor	terminal No. 2

### Connection to sensors with output „S“, Namur, contact

+ U of sensor	terminal No. 3
0 V of sensor	terminal No. 2

### Sensor type selection

NPN, „S“, Namur, contact	terminal No. 4 must be connected to terminal No. 5
PNP	terminal No. 4 must be connected to terminal No. 1

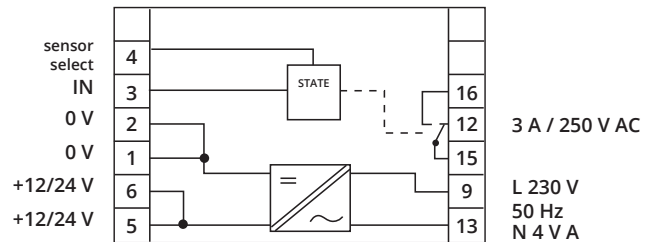

## BLOCK AND WIRING DIAGRAM DSU-1222 / 2422

### Connection to sensors with NPN, PNP output

+ U of sensor	terminal No. 5 or 6
output (Q) of sensor	terminal No. 3 or 4
0 V of sensor	terminal No. 1 or 2

### Connection to sensors with output „S“, Namur, contact

+ U of sensor	terminal No. 3 or 4
0 V of sensor	terminal No. 1 or 2

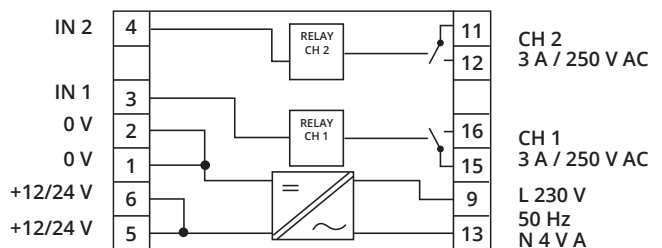

## Sensor type selection DSU-1222 / 2422

### switch „P / N“

- position P
  - the unit responds to the current flowing into the input terminal (No. 3 or 4)
  - for PNP type sensors
- position N
  - the unit responds to the current flowing from the input terminal (No. 3 or 4) out
  - for NPN, „S“, Namur, or voltage-free contact output sensors

### switch „O / C“

- position O
  - the output contact is switched on when current flows through the input circuit (the relay state repeats the sensor state)
- position C
  - inverse function
  - the output contact is closed if no current flows through the input circuit (the relay state negates the sensor state)

# MARKING OF LABELS

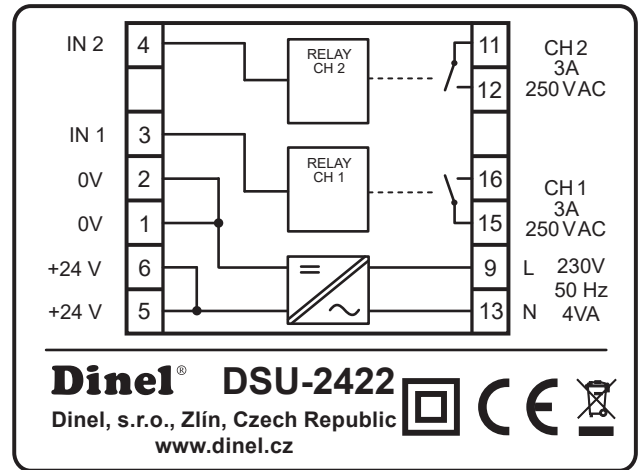
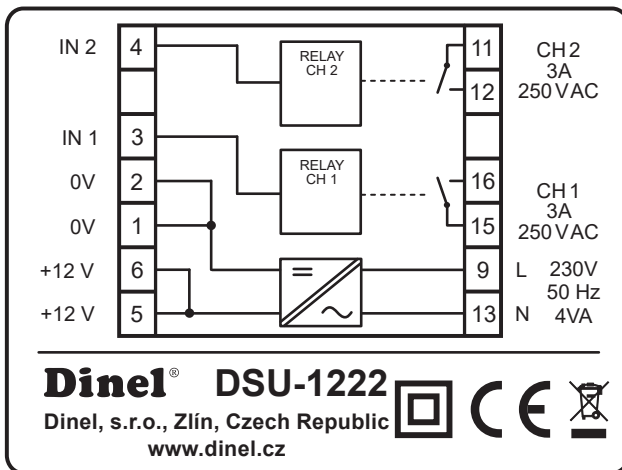
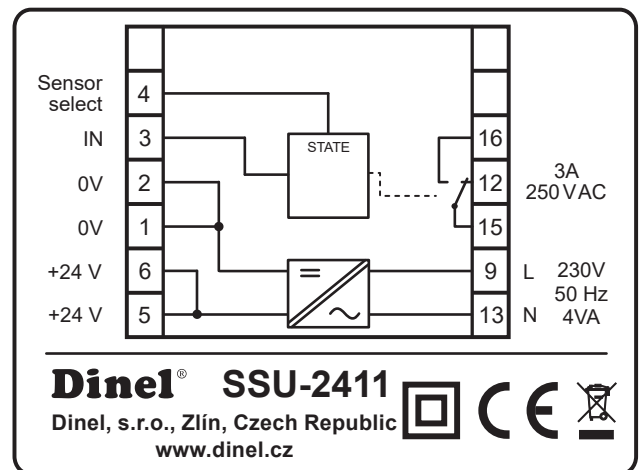
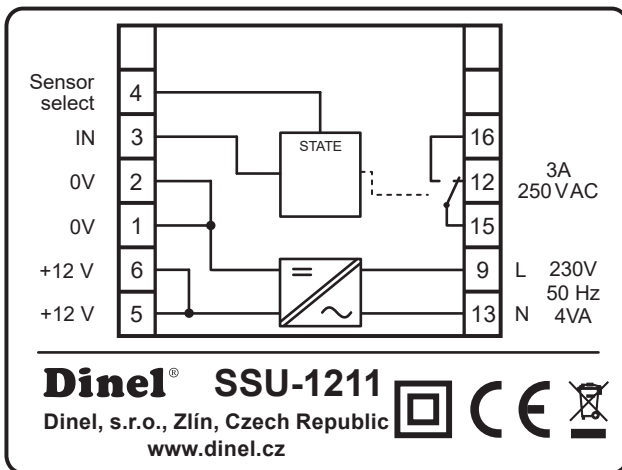

Symbol of producer: logo Dinel®  
 Internet address: [www.dinel.cz](http://www.dinel.cz)  
 Country of origin: Made in Czech Republic  
 Double insulation sign (equipment protection class II.):   
 Compliance mark:   
 Electro-waste take-back system mark:   
 Block and wiring diagram.

## WIRING SSU-1211 / 2411

- The SSU-1211 / 2411 is designed to connect one limit sensor. It contains one contact for input signal (terminal 3) and relay contact (12, 15, 16). The sensor type is determined by connecting terminal 4 to terminal 1 or 5 (see electrical connection).

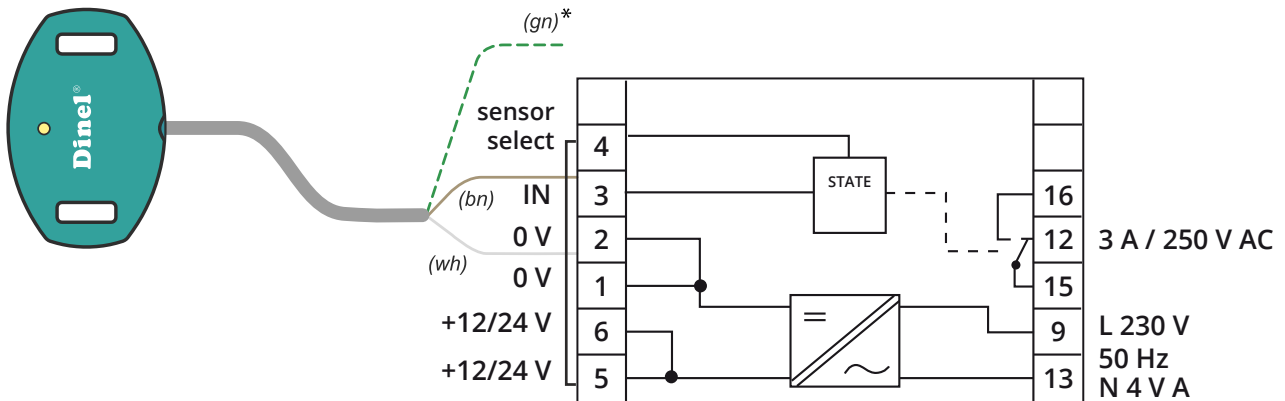

## WIRING DSU-1222 / 2422

- The DSU-1222 / 2422 is designed to connect two limit sensors. It contains two contacts for input signals (terminal 3 and 4) and relay contacts (11, 12 and 15, 16). Setting of the unit is done by switches located on the front of the unit (see electrical connections).

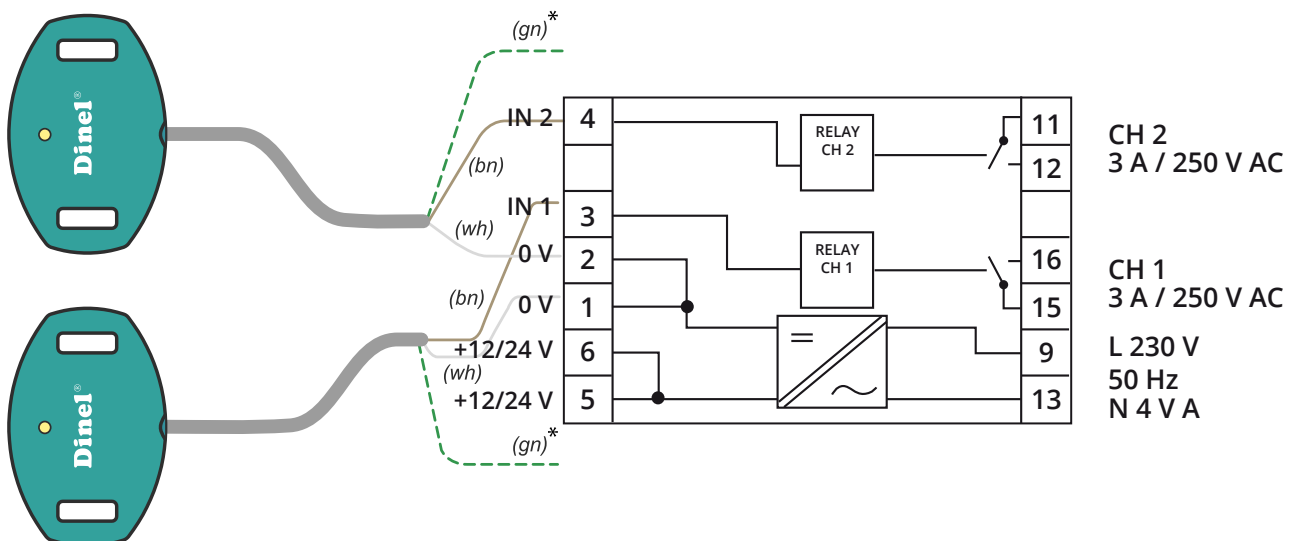

# SAFETY, PROTECTION, COMPATIBILITY

The units include overload or short circuit protection at the output terminals. Electrical equipment of protection class II. Connection to 230 V mains only via a switch or circuit breaker.

Electrical safety according to EN 61010-1. Electromagnetic compatibility (EMC) is ensured by compliance with EN 61000-4-2, -3, -4, -5, -6 and -11; EN 55011 and EN 61326-1.

The device must only be connected to the power supply via an easily accessible switch with marked off/on positions and must be protected by a fuse or circuit breaker with a maximum value of 16 A!

**The electrical connection must only be made in a voltage-free state!**



**The switch or circuit breaker used as a disconnecting means must comply with IEC60947-1 and IEC60947-3, must be marked and must not be in the mains supply.**

**All operations described in these operating instructions must only be carried out by a trained person or a certified person. Warranty and post-warranty repairs must be carried out only by the manufacturer.**



**Improper use, installation or adjustment can lead to application failures (tank overfilling or damage to system components).**

**The manufacturer is not liable for misuse, work loss resulting from either direct or indirect damage, or expenses incurred in the installation or use of the unit.**



Sensormatic srl - Via della Beverara 13 - 40131 Bologna - Italia  
Tel. +39 051 6353 511 - [www.sensormatic.it](http://www.sensormatic.it)

SSU-1211 / 2411; DSU-1222 / 2422-dat-8/8

**Dinel, s. r. o.**  
U Tescomy 249, 760 01 Zlín, Czech Republic  
**tel.: +420 577 002 000**  
**e-mail: [sale@dinel.cz](mailto:sale@dinel.cz)**

**[www.dinel.cz](http://www.dinel.cz)**

version:  
10/2021