

High-frequency limit level sensor with elimination of buildups and foam on the electrode.



- Designed for reliable limit sensing of the level height of wide-ranging fluids, mashed and paste-like materials.
- Resistant to adhesion of viscous and sticky media.
- Replacement of a vibrating level sensor.
- Unique material type recognition function „Medium window“ (the sensor only senses the set medium and does not react to substances with a lower and higher permittivity).
- Direct mounting into tanks, vessels, sumps, pipes or funnels and containers.
- Settings using the magnetic pen.
- High stability at high sensitivity (possible to use for substances with $\epsilon_r \geq 1.5$).



The high-frequency level sensor RFLS-35 is designed for industrial use for limit sensing of the level of liquid and paste-like media. The high-frequency level sensor may be a direct replacement of a vibrating level sensor, or of a capacity level sensor in case of more demanding applications. The media may be electrically conductive or non-conductive with any permittivity. It can be installed in metal or plastic tanks, pipes, filling tanks, sumps, etc.

It is mainly designed for mounting into the wall of a tank or pipe, in which the actual detection of the level will take place. The sensor works in the high frequency band, enabling reliable detection of the level of media, and eliminating deposits or foam on the electrode. The sensor suppresses the influence of deposits of viscous media (ketchup, yoghurt, pastes, syrups, jams and jellies, creams, soap) as well as electrically conductive adhesive products (detergents, alkalis, chemicals).

Likewise, it is possible to utilize it to differentiate a specific media from others - the "Medium window" function. E.g. it can differentiate oil from water and air, detect only beer foam and ignore beer and air, etc.

The sensor is made from a stainless steel housing at one end terminated by a sensing electrode, and terminated at the other end by an ending with a status indicator, control elements and electrical connection.

There are next performances available: **N** – For normal atmospheres, **Xi** – Explosion proof – intrinsically safe for hazardous (explosive) areas. and **XiM** – Explosion proof – intrinsically safe for use in mines with methane or flammable dust presence danger (see technical specifications).

VARIANTS OF SENSORS

- RFLS-35_-1B **Insulated electrode (PEEK) with sealing O-ring NBR**, for sensing various liquid, mashed and paste-like materials, appropriate also for fuel, oil or methanol, use from minimum temperature of -40 °C.
- RFLS-35_-11B **Insulated electrode (PEEK) extended version with sealing O-ring NBR**, for sensing various liquid, mashed and paste-like materials, appropriate also for fuel, oil or methanol, use from minimum temperature of -40 °C
- RFLS-35_-1E **Insulated electrode (PEEK) with sealing O-ring EPDM**, for sensing various liquid, mashed and paste-like materials, appropriate also for acids, bases or alcohol, ammonia, acetone, chlorine, from minimum temperature of -40 °C.
- RFLS-35_-11E **Insulated electrode (PEEK) extended version with sealing O-ring EPDM**, for sensing various liquid, mashed and paste-like materials, appropriate also for acids, bases or alcohol, ammonia, acetone, chlorine, from minimum temperature of -40 °C

- **RFLS-35_-1V** **Insulated electrode (PEEK) with sealing O-ring Viton**, for sensing various liquid, mashed and paste-like materials, appropriate also for fuel, oil, acids, bases or asphalt, tar, toluene, use from minimum temperature of -20 °C.
- **RFLS-35_-11V** **Insulated electrode (PEEK) extended version with sealing O-ring Viton**, for sensing various liquid, mashed and paste-like materials, appropriate also for fuel, oil, acids, bases or asphalt, tar, toluene, use from minimum temperature of -20 °C
- **RFLS-35_-2** **Insulated electrode (PTFE) without O-ring**, for sensing various liquid, mashed and paste-like materials, especially suitable for aggressive liquids, use from minimum temperature of -40 °C.
- **RFLS-35_-21** **Insulated electrode (PTFE) extended version without O-ring**, for sensing various liquid, mashed and paste-like materials, especially suitable for aggressive liquids, use from minimum temperature of -40 °C.

DIMENSIONAL DRAWINGS

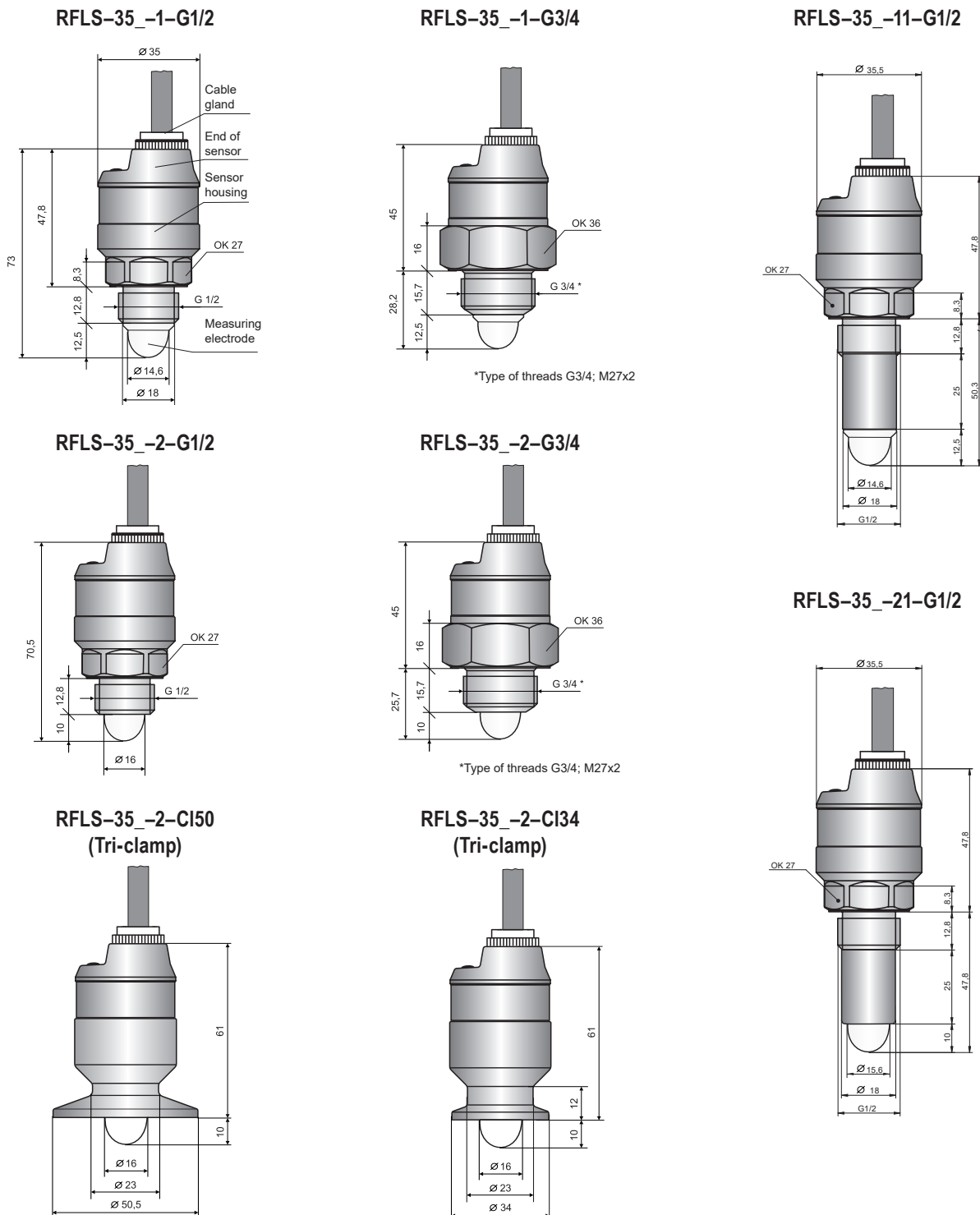

Variant "A" with short stainless steel gland

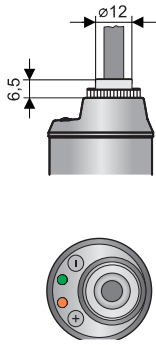

Variant "B" with plastic threaded cable gland

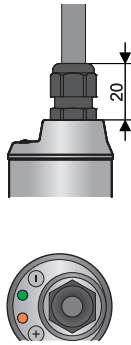

Variant "C" with connector M12

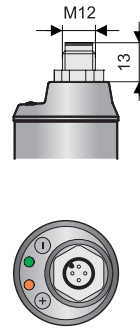

Variant "D" with dustproof cable outlet

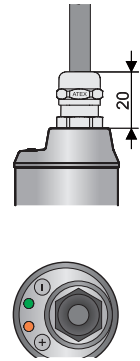

Variant "V" with plastic cable gland with spiral relief – in case of increased mechanical wear on the cable.

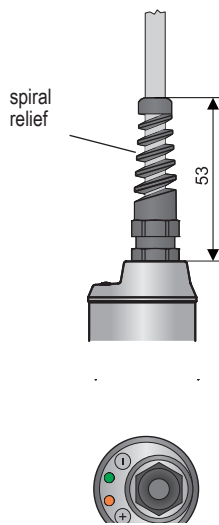

Variant "H" with cable gland for protected hoses – for using in an outdoor area or in area with increased moisture.

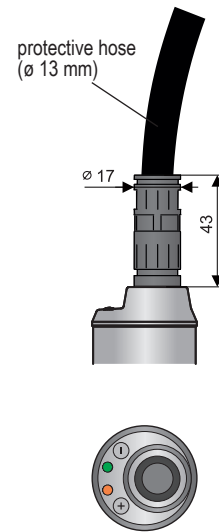

SENSOR SWITCHING LEVELS

horizontal mounting

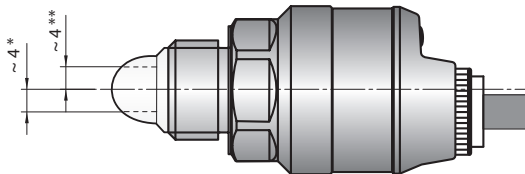

* Typical switch point position for water (factory setting).
 ** Typical switch point position for oil.

montáž svisle

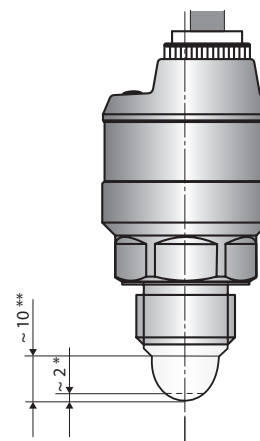

TECHNICAL SPECIFICATIONS

BASIC TECHNICAL DATA

| | | |
|---|-------------------------------|------------------------------|
| Supply voltage (variant RFLS-35N) | 7 ... 34V DC | |
| Power consumption (variant RFLS-35N) | max. 5 mA DC | |
| Max. switching current (PNP output) | 300mA | |
| Residual voltage – ON state | max. 1,5 V | |
| Coupling capacity (housing - power) / dielectric strength | 5 nF / 500 V AC (50 Hz) | |
| Ambient temperature range: | -40 ... +80 °C | |
| Protection class | type RFLS-35_--_C-__ | IP 67 |
| | type RFLS-35_--_A(B,V,H,D)-__ | IP 68 |
| Cable (versions with cable outlets) | Variant (P,N) | PVC 3 x 0,5 mm ² |
| | Variant (Xi, XiM) | PVC 2 x 0,75 mm ² |
| Weight (without cable) | cca 0,15kg | |

ELECTRICAL PARAMETERS – variant Xi and XiM

| | |
|---|--|
| Power supply voltage | 8 ... 9 V DC |
| Current consumption (disconnected/ connected) – NAMUR | ≤ 1 mA / ≥ 2,2 mA |
| Max. internal values | U _i = 12VDC; I _i = 15mA; P _i = 45mW; C _i = 15 nF; L _i = 10 μH |
| Cables LC values | typic C < 150 pF/m typic L < 0,8 μH/m |

USED MATERIALS

| part of the sensor | | standard material * |
|-------------------------------------|------------------|--|
| Housing | | stainless steel W.Nr. 1.4404 (AISI 316L) |
| End of sensor | | stainless steel W.Nr. 1.4301 (AISI 304) |
| Electrode coating | type el. 1, 11 | PEEK |
| | type el. 2, 21 | PTFE |
| Sealing O-ring | RFLS-35_-1B, 11B | NBR |
| | RFLS-35_-1E, 11E | EPDM |
| | RFLS-35_-1V, 11V | (FPM) Viton |
| | RFLS-35_-2, 21 | – |
| Cable gland (variant "A") | | stainless steel W.Nr. 1.4571 / NBR |
| Cable gland (variant "B", "V", "H") | | plastic PA / NBR |
| Cable gland (variant „D“) | | nickel-plated brass / PA / CR / NBR |
| Connector M12 (variant "C") | | nickel-plated brass / PA |

* Verify chemical compatibility with the media. Upon agreement it is possible to select a different type of material.

PROCESS CONNECTION

| type | size | marking |
|------------------------------------|----------------------|--------------|
| Pipe thread | G 1/2" | G1/2 |
| Pipe thread | G 3/4" | G3/4 |
| Metric thread | M27x2 | M27 |
| Jointless connection (Tri-Clamp) * | ø 34 mm ø 50,5 mm | CI34 CI50 |

* only for type electrode 2

TYPE OF OUTPUT

| Output | Variants |
|----------------|----------|
| PNP (PC; PO) | N |
| NAMUR (RC; RO) | Xi (XiM) |

PARAMETERS OF FUNCTIONAL SAFETY

| variant of sensor | RFLS-35_--_P(R) | RFLS-35N-__-PD |
|---|--------------------------|--------------------------|
| according to standard | EN 61508 ed.2 | |
| Safety function | MIN, MAX | |
| SIL | 2 | |
| Hardware architecture | 1oo1 without diagnostic | 1oo1 with diagnostic |
| DC | 0 % | 99 % |
| PFH (T _{Proof} = 1 rok) (for variant N) | 2,218 * 10 ⁻⁷ | 2,218 * 10 ⁻⁹ |
| PFH (T _{Proof} = 1 rok) (for variant Xi) | 2,238 * 10 ⁻⁷ | - |
| λ _{DD} (for variant N) | 0 FIT | 219,6 FIT |
| λ _{DU} (for variant N) | 221,8 FIT | 2,2 FIT |
| λ _{DD} (for variant Xi) | 0 FIT | - |
| λ _{DU} (for variant Xi) | 223,8 FIT | - |
| MTTF _D (for variant N) | 514 years | |
| MTTF _D (for variant Xi) | 510 years | - |
| valid version FW | v2 | v3-diagnostic |

Explanations:

SIL Safety integrity level,
DC Diagnostic cover,
PFH.....Average frequency of dangerous failure per hour
T_{Proof}.....Functional control period of the device safety function
λ_{DD(DU)}.....Detected (resp. undetected) dangerous failure rate per hour
MTTF_D.....Mean Time To dangerous Failure

DEVICE CLASSIFICATION

| Sensor performance | Device classification and their use in atmosphere | according to standard EN |
|--------------------|---|--------------------------|
| RFLS-35N | Basic performance | - |
| | For non-explosive atmosphere | - |
| RFLS-35Xi | Equipment protection by intrinsic safety "i" for use in potentially explosion atmosphere, Ⓜ II 1 G Ex ia IIB T5 Ga with intrinsically safe supply units | 60079-0, 60079-11 |
| | For use in hazardous area (explosive gas atmosphere), whole sensor zone 0 | 60079-10-1 |
| RFLS-35XiM | Equipment protection by intrinsic safety "i" for use in potentially explosion atmosphere, Ⓜ IM1 Ex ia I Ma with intrinsically safe supply units. | 60079-0, 60079-11 |
| | For use in the mine area with the occurrence of methane or coal dust | 60079-10-1 |

The device or its part intended for zone 0 can also be used in zone 1 or 2.

TEMPERATURE AND PRESSURE DURABILITY – variant N, Xi and XiM

| design variant | temperature tp | temperature ta | maximum overpressure | temperature tp for ta <50°C and t <1h |
|----------------------------|------------------|-----------------|------------------------------------|---------------------------------------|
| RFLS-35N-1B (1E, 11B, 11E) | -40°C ... +105°C | -40°C ... +80°C | 10 MPa | max. 120 °C |
| RFLS-35Xi(XiM)-1B (1E) | -40°C ... +100°C | -40°C ... +80°C | 10 MPa | max. 100 °C |
| RFLS-35N-1V (11V) | -20°C ... +105°C | -40°C ... +80°C | 10 MPa | max. 120 °C |
| RFLS-35Xi(XiM)-1V | -20°C ... +100°C | -40°C ... +80°C | 10 MPa | max. 100 °C |
| RFLS-35N-2 (21) | -40°C ... +105°C | -40°C ... +80°C | 5 MPa to 50°C 2,5 MPa over 50°C | max. 120 °C |
| RFLS-35Xi(XiM)-2 (21) | -40°C ... +100°C | -40°C ... +80°C | 5 MPa to 50°C 2,5 MPa over 50°C | max. 100 °C |

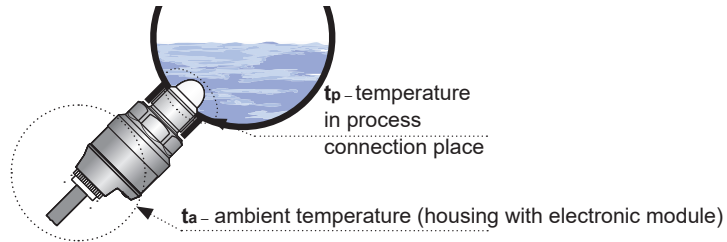

INSTALLATION INSTRUCTIONS

RFLS level sensors can be mounted in horizontal or inclined position into the shell of a container, storage tank or pipe by screwing into the welding flange, or by affixing using a nut. Basic application recommendations are mentioned below.



During assembly into the metal tank or the storage tank, it is not necessary to separately ground the base of the level sensor



In the case of the use for an aggressive medium is necessary to prove the chemical compatibility of used materials of the sensor (Tab. Used materials). This guarantee ceases when the product is chemically damaged.

Thanks to its design, the sensor is appropriate for detection of the level of **viscous and simultaneously electrically conductive media** (yoghurt, jams and jellies, mayonnaise, spreads, liquid soap, creams or pastes). After setting the sensitivity of the given media, it reliably reacts to the presence or absence of a medium level. On the contrary, the sensor does not react to remnants and coatings of viscous media on the measuring electrode.

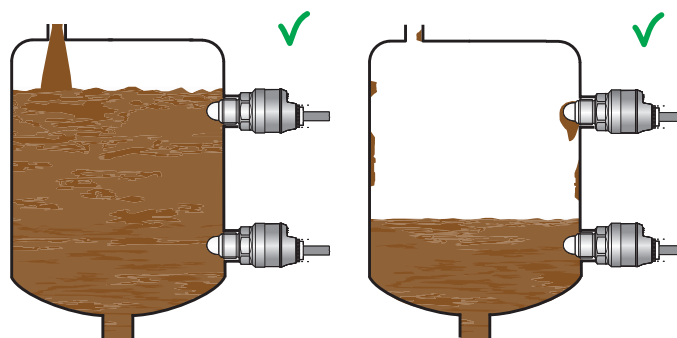

Side installation of sensors into a tank with viscous medium

It is recommended to install sensors in a horizontal pipe **inclined from the side**.

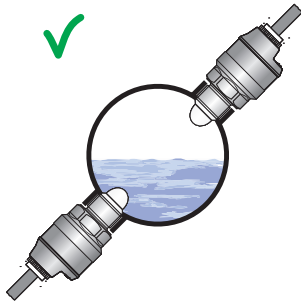

Upon vertical installation of the sensor in a pipe, pay attention to potential formation of air pockets,

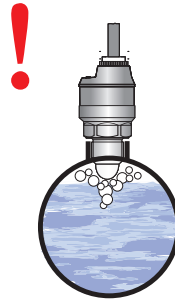

or adhering remnants of liquid at the bottom of the pipe.

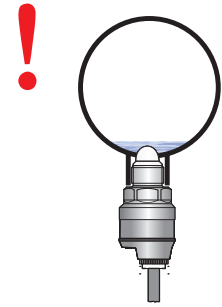

Installation of the sensor in a pipe

In the case of **side wall mounting**, it is necessary to avoid long fitting tubes, where sensed medium could remain. We recommend mounting the sensor so that the whole measuring electrode is inside the tank.

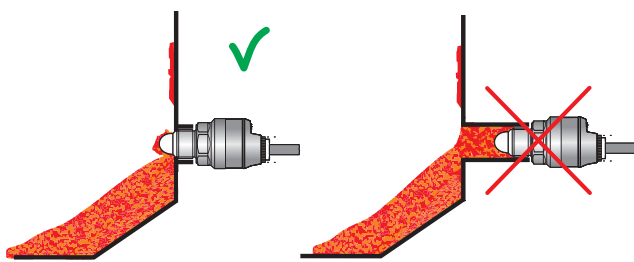

Correct and incorrect installation with a long tube

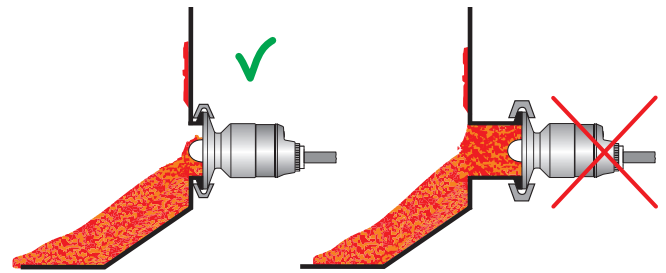

Correct and incorrect installation with a long tube for process connection with Tri-Clamp



Small Tri-clamp (ø 34 mm), only for liquids with low viscosity.

Installation of the sensor for reliable checking of the level of a liquid with foam on the surface. Sensitivity of the sensor can be set to detect the liquid interface with foam. After a drop in the liquid level, the sensor does not react to coatings of foam on the electrode.

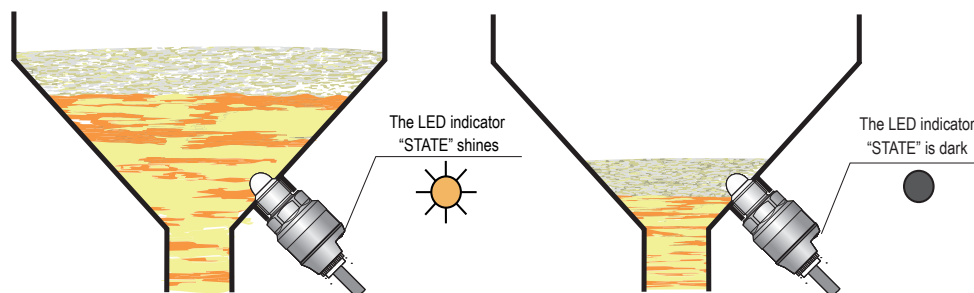

Monitoring the level of foam media

The sensor can be mounted in a tank or at medium inlets. After setting to the level of the given media the sensor does not react to the current of flowing medium.

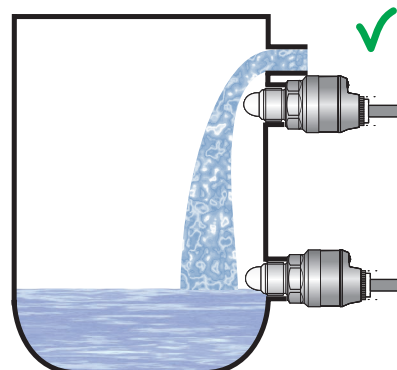

Option of mounting the sensor in the medium inlet

ELECTRICAL CONNECTION

A sensor with PNP output can be loaded only by resistive or inductive load. The positive pole of the supply voltage (+U) is connected to the brown wire BN or pin connector no.1, the negative pole (0V) is connected to the blue wire BU or pin connector no. 3 and load on the black wire BK or pin connector no. 4. The capacitive loads and low resistance loads (bulb) are evaluated by the sensor as a short circuit.

Connection diagrams are listed in Figures right.

Sensors RFLS-35 with type of cable outlet A, B, V, D or H are connected to assessing units permanently connected by PVC cable.

Sensors RFLS-35 with connection method type C are connected to control units by means of a connector socket with compression cable (length 2 or 5 m), or by means of dismantable connector socket without cable (see accessories), connector socket is not part of the sensor. In this case the cable is connected to the inside pins of the socket according to Figure right. The recommended diameter of this cable is 4 to 6 mm (the recommended cross-sectional area is 0.5 to 0.75 mm²).

The connection of the sensor to the connecting device is performed using a suitable three wire (variant N) or two wire (variant Xi and XiM) cable. The length of the cable for the Xi and XiM variations must be selected with respect to the maximum permitted parameters (usually inductance and capacity) of the outside intrinsically safe circuit of supply units (NSSU, NDSU, NLCU).

In the event that dismantable connector sockets are used, the outer diameter of the cable is max. 6 mm.

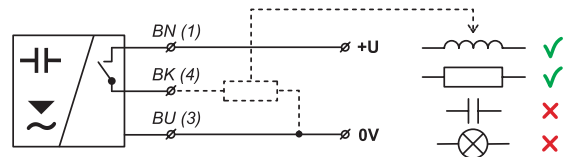

PNP output type sensor connection

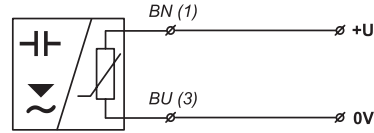

NAMUR type sensors connection (variants Xi and XiM)

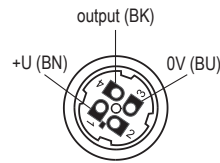

Inside of the connector socket (type ELWIKA or ELKA)

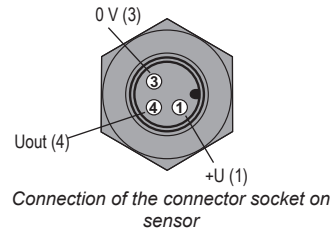

Legend:

(1,...) – numbers of terminals inside the connector socket
 BK – black
 BN – brown
 BU – blue



Electrical connection can only be made when de-energized!

The source of the power voltage must comprise of a stabilised safe low power source with galvanic separation. In the event that a switch-mode power supply is used, it is essential that its construction effectively suppresses common mode interference on the secondary side. In the event that the switch-mode power supply is equipped with a PE safety terminal, it must be unconditionally grounded! Spark-safe devices type (RFLS-35Xi and RFLS-35XiM) must be powered from a spark-safe power source meeting the above-mentioned requirements.



In the event that the level meter (sensor) is installed in an outdoor environment at a distance greater than 20 m from the outdoor switchboard, or from an enclosed building, it is necessary to supplement the electrical cable leading to the level meter (sensor) with suitable overvoltage protection.

With regard to possible occurrence of electrostatic charge on non-conductive parts of the sensor for explosive areas (RFLS-35Xi and RFLS-35XiM), sensors must be grounded. It will be done using conductive tank, conductive lid of tank, or by the auxiliary plate electrode PDE-27.

In the event of strong ambient electromagnetic interference, paralleling of conductors with power distribution, or for distribution to distances over 30 m, we recommend grounding the level meter (see above) and using a shielded cable.

CONTROL ELEMENTS

Settings are performed by placing the magnetic pen on the sensitive spot marked “+” or “-” located at the end of the sensor in two modes:

1. Quick settings - the user does not know precisely to what medium the sensor should be set, he only wants to put the sensor into operation (usually upon receiving it) and check to see if the sensor is generally functional
2. Basic settings - the user has the medium available and can perform on the sensor its flooding and drainage
3. Medium window settings - the user has the medium available and can perform on the sensor its flooding and drainage

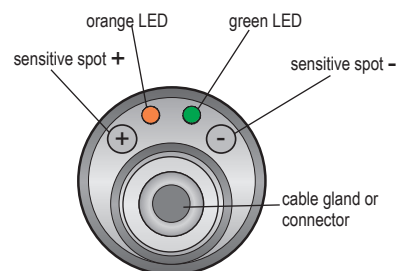







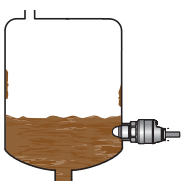

Top view of sensor control elements

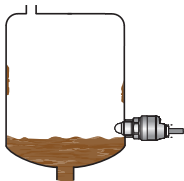
FUNCTION AND STATUS INDICATION

| LED indicator | colour | function |
|---------------|--------|--|
| "RUN" | green | Measuring function indication flashing – (approx. 0.4 s) – correct function of level detection dark – incorrect installation or malfunction. alternating flashing of the green and orange LED – error in settings simultaneous shine of green and orange LED – when applying the mag. pen, when the setting is confirmed |
| "STATE" | orange | Settings indication permanent shine – the sensor is closed dark – the sensor is open 3 short flashes – settings confirmed alternating flashing of the green and orange LED – error in settings simultaneous shine of green and orange LED – when applying the mag. pen, when the setting is confirmed periodic extinction (0,1 s) in closed mode - diagnosed function error periodic lighting (0,1 s) in open mode - diagnosed function error |

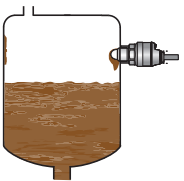
*) Function accessible for variant PD (electronic with diagnostic).

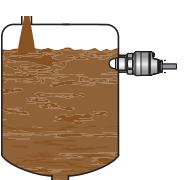
| | level state | mode | output state | state indicator |
|-----------------------|---|------|--------------|--|
| minimum level sensing |  | O | CLOSED |  (illuminated) |
| |  | O | OPEN |  (not illuminated) |

| | level state | mode | output state | state indicator |
|-----------------------|---|------|--------------|--|
| maximum level sensing |  | C | CLOSED |  (illuminated) |
| |  | C | OPEN |  (not illuminated) |

For safety reasons, we recommend using the setting of the mode "O" for min. level sensing (the sensor is closed upon immersion). It is for failure safety reasons – eventual failure of sensor behaves similarly as an exceeding of the limit state. Analogically, for the max. level it is recommended to set the mode "C" (the sensor is open upon immersion).

ORDER CODE

PRODUCT

RFLS-35

PERFORMANCE

| | |
|------------|--|
| N | basic performance for non-explosive area, can't be selected for the type of output R |
| Xi | ☠ for hazardous area (explosive gas atmosphere), can't be selected for the type of output P |
| XiM | ☠ for mine area with the occurrence of methane or coal dust, can't be selected for the type of output P |

TYPE OF ELECTRODE

| | |
|------------|--|
| 1B | insulated electrode (PEEK, O-ring NBR), can't be selected for process connection C134, C150 |
| 11B | insulated electrode (PEEK, O-ring NBR) - extended version, can't be selected for process connection G3/4, M27, C134, C150 |
| 1E | insulated electrode (PEEK, O-ring EPDM), can't be selected for process connection C134, C150 |
| 11E | insulated electrode (PEEK, O-ring EPDM) - extended version, can't be selected for process connection G3/4, M27, C134, C150 |
| 1V | insulated electrode (PEEK, O-ring Viton), can't be selected for process connection C134, C150 |
| 11V | insulated electrode (PEEK, O-ring Viton) - extended version, can't be selected for process connection G3/4, M27, C134, C150 |
| 2 | insulated electrode (PTFE, without O-ring) |
| 21 | insulated electrode (PTFE, without O-ring) - extended version, can't be selected for process connection G3/4, M27, C134, C150 |

PROCESS CONNECTION

| | |
|-------------|--|
| G1/2 | pipe thread G 1/2" |
| G3/4 | pipe thread G 3/4", can't be selected for 11B, 11E, 11V a 21 |
| M27 | metric thread M27 x 2, can't be selected for 11B, 11E, 11V a 21 |
| C134 | Tri-clamp (ø 34 mm), can be selected only for 2 |
| C150 | Tri-clamp (ø 50,5 mm), can be selected only for 2 |

TYPE OF OUTPUT

| | |
|-----------|--|
| N | NPN (open collector) |
| P | PNP (open collector), for variant N |
| PD | PNP (open collector) with diagnostic, for variant N |
| R | NAMUR (for variants Xi a XiM) |

ELECTRICAL CONNECTION

| | |
|----------|---|
| A | stainless steel compression gland (+ cable length) |
| B | plastic threaded cable gland (+ cable length) |
| C | connector (socket not included with sensor, recommended type - see accessories) |
| D | nickel-plated brass threaded cable gland (+ cable length) |
| V | plastic cable gland with spiral (+ cable length) |
| H | plastic cable gland for protective hose (+ cable length) |

CABLE

| | |
|----------|-------------------|
| K | cable length in m |
|----------|-------------------|

RFLS-35 N - 2 - CL50 - P - B - K 5

MOŽNÁ VARIANTA VÝROBKU

ACCESSORIES

standard - included in the sensor price **optional – for a surcharge** (see cat. sh. of accessories)

- 1 pcs. magnetic pen MP-8
- 1 pcs. seal (asbestos free)
- cable (over the standard length 2m)
- connector socket (type ELWIKa or ELKA)
- standard steel welding flange or stainless steel welding flange protective hose (for cable outlet H)
- stainless steel fixing nut
- various types of seals (PTFE, AI, etc.)

SAFETY, PROTECTIONS, COMPATIBILITY AND EXPLOSION PROOF

The level sensor is equipped with protection against electric shock on the electrode, reverse polarity, output current overload, short circuit and against current overload on output.

Protection against dangerous contact is provided by low safety voltage according to 33 2000-4-41. Electromagnetic compatibility is provided by conformity with standards EN 55011/B, EN 61000-4-2 to -6 and -8.

Explosion proof RFLS-35Xi (XiM) is provided by conformity with standards EN 60079-0, EN 60079-11, EN 50303. Explosion proof RFLS-27Xi (XiM) is verified FTZÚ – AO 210 Ostrava – Radvanice: FTZÚ 16 ATEX 0139X.

A declaration of conformity was issued for this device in the wording of Act No. 90/2016 Coll., as amended. Supplied electrical equipment matches the requirements of valid European directives for safety and electromagnetic compatibility.

Special conditions for safe use of variants RFLS-35Xi and RFLS-35XiM

Sensors RFLS-35Xi and RFLS-35XiM are intended for connection to approved intrinsically safe supply units (insulating transducers) with galvanic separation. In the event that devices without galvanic separation (Zener barriers) are used, it is necessary to balance the potential between the sensor, resp. water level meter and the grounding barrier location.

The limit output parameters of intrinsically safe supply units (insulating transducers) must correspond to the limit input parameters of the sensor, resp. level meter. When assessing intrinsically safety of circuits, it is necessary to also take into consideration the parameters of the connected cable (namely its induction and capacity).

Design RFLS-35Xi can be used in zone 0.

Design RFLS-35XiM it is necessary to observe that temperature of any surface of apparatus, when coal dust can from a layer, do not exceed 100°C.

FUNCTIONAL SAFETY

RFLS-35 high-frequency level sensors meet the requirements of the safety integrity level according to the EN 61508 series of standards. The sensors are designed for liquid level detection applications with higher safety requirements:

- Overfill protection mode
- Anti-idle protection mode

The sensors meet the functional safety requirements of SIL 2 in both modes.

The sensor electronics have a 1oo1 architecture (single channel without P(R) diagnostics or single channel with PD diagnostics depending on the output variant).

It is recommended to perform a functional safety function check of the sensor once a year.

USE, MANIPULATION AND MAINTENANCE

The level meter does not require any personnel for its operation. Maintenance of this equipment consists in verification of integrity of the level meter and of the supply cable.

Activity in traffic:

- If the sensor is connected to an automatic control system or an emergency alarm system, its settings must not be interfered with during operation.
- If it is necessary to change the sensor settings, the entire system must be temporarily shut down and the process kept in a safe state by other means and measures.
- The signalling of fault conditions is described in the chapters.
- Signalling conditions or Signalling sensor conditions with diagnostics.

Action in the event of a fault:

- In the event of detected faults or fault signals, the entire system must be shut down and the process held in a safe state by other means and measures.
- If, as a result of a fault, sensor replacement is required, the manufacturer must be notified (including a description of the fault).