

# IDEM VIPER DIN Rail Power Supply TYPE DRS-2415

## DESCRIPTION:

The Viper DRS-2415 Power Supply from IDEM Safety Switches has been designed to provide regulated 24VDC power to devices such as safety switches and safety relays. The DRS-2415 has both short circuit and over-voltage protection built in, this is in addition to a "DC OK" voltage free signal contact to indicate the status of the DC power.



## FEATURES:

- Wide input range (85-265V AC).
- DC OK indication and signal contact.
- 6 output voltage terminals for multiple connections.
- 22.5mm DIN rail mountable enclosure.
- 24 Vdc output 15W/0.63A.
- Over-Voltage protection.
- Short circuit protection.
- The DRS-2415 requires no maintenance, there are no serviceable parts.

## INTERNAL BLOCK DIAGRAM AND TERMINAL CONNECTION:

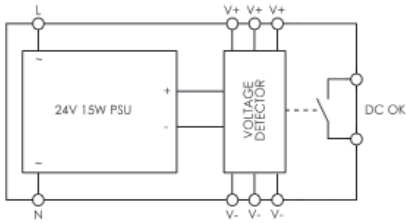

### Terminal Connections

- L Live Connection VAC Supply
- N Neutral Connection VAC Supply
- + +24VDC Output Connection
- 0VDC Output Connections
- DC OK DC Status Signal Output
- Closed = 'OK'

DC OK	-	-	-
DC OK	+	+	+

24VDC/0.63A DC OK

DRS-2415

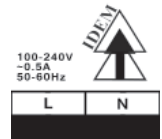

## CONNECTION EXAMPLE:

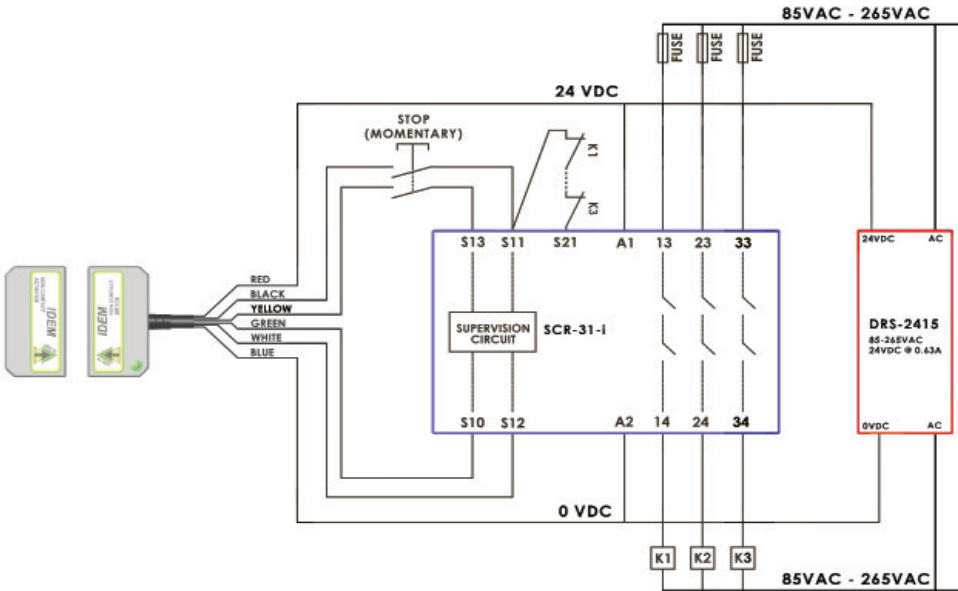

## SPECIFICATIONS:

Specifications:	
AC Input Voltage Range	85 – 265 Vac
Input Frequency	50 – 60 Hz
Inrush Current	30A at 240Vac, cold start at 25°C
Input Current (115/230VAC)	0.4 / 0.2 A
Output Voltage	24 Vdc
Output Current	0.63 A
Load Regulation	±1% (10% to 100% load)
Line Regulation	±0.5% (100-240VAC line change)
Ripple & Noise	1% or 50mV whichever is greater
Short Circuit Protection	Continuous – hiccup mode
Over-voltage Protection	130-150%, Zener clamp
Efficiency	75%
Operating Temperature	0 - +55°C
Storage Temperature	-20 - +85°C
DC OK Signal Contact Rating	24Vac/dc, 200mA

## DIMENSIONS:

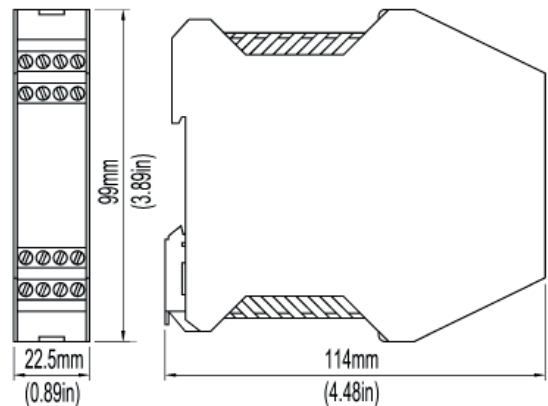

SALES NUMBER	DESCRIPTION
180040	DRS-2415 DIN Rail Power Supply 85 - 265Vac